

NIETZ



NIETZ ELECTRIC CO.,LTD

- Thank you very much for your buying NZ2000 series High-performance Vector Control Inverter.
- Before use, please read this manual thoroughly to ensure proper usage. Keep this manual at an easily accessible place so that can refer anytime as necessary.

Safety Precautions

Please read this operation manual carefully before installation, operation, maintenance or inspection. In this manual, the safety precautions were sorted to "WARNING" or "CAUTION".



WARNING

Indicates a potentially dangerous situation which, if can not avoid will result in death or serious injury.



CAUTION

Indicates a potentially dangerous situation which, if can not avoid will cause minor or moderate injury and damage the device. This Symbol is also used for warning any un-safety operation.

In some cases, even the contents of "CAUTION" still can cause serious accident. Please follow these important precautions in any situation.

In some cases, even the contents of "CAUTION" still can cause serious accident. Please follow these important precautions in any situation.

In some cases, even the contents of "CAUTION" still can cause serious accident. Please follow these important precautions in any situation.

★ NOTE indicate the necessary operation to ensure the device run properly.

Warning Marks are placed on the front cover of the inverter.

Please follow these indications when using the inverter.

WARNING
<ul style="list-style-type: none"> • May cause injury or electric shock. • Please follow the instructions in the manual before installation or operation. • Disconnect all power line before opening front cover of unit. Wait at least 10 minutes until DC Bus capacitors discharge. • Use proper grounding techniques. • Never connect AC power to output UVW terminals.

Contents

Chapter 1 Introduction	1
1.1 Technology Features	1
1.2 Description of Name Plate.....	3
1.3 Selection Guide	4
Chapter 2 Installation and wiring	6
2.1 Environment and installation requirements	6
2.2 The opening size of the keyboard	10
2.3 The Inverter Wiring	10
2.3.1 The inverter wiring of the main part	10
2.3.2 the descriptions of peripheral devices	11
2.3.3 Precautions main circuit wiring	12
2.3.4 Device recommended specifications	12
2.3.5 Main circuit terminals and description.....	14
2.4 Control Terminals.....	16
2.4.1 Control Terminal Description.....	17
Chapter 3 Operation	19
3.1 Digital Operator Description	19
3.1.1 the picture of the panel	19
3.1.2 the descriptions of the key's function	20
3.1.3 Indicator light descriptions	20
3.2 Operational process	21
3.2.1 Parameter Settings	21

3.2.2 Fault reset.....	22
3.2.3 Motor parameter self learning.....	22
3.3 Running state	23
3.3.1 Power-on initialization	23
3.3.2 Standby status	23
3.3.3 Motor parameters self-learning	23
3.3.4 Running	23
3.3.5 Failure.....	23
3.4 Quick commissioning	23
Chapter 4 Detailed Function Description	25
Chapter 5 Fault checking and ruled out.....	120
5.1 Fault alarm and countermeasures.....	120
5.2 Common Faults and Solutions	125
Chapter 6 Maintenance	128
6.1 Inspection	128
6.2 Periodic Maintenance.....	128
6.3 Replacement of wearing parts.....	129
6.4 Inverter Warranty.....	129
Chapter 7 Peripheral Devices Selection.....	130
7.1 Peripheral Devices Description	130
7.2 Applied Braking resistor Specification	131

Appendix A List of Function Parameters	134
Appendix B Communication Protocol.....	174

Chapter 1 Introduction

1.1 Technology Features

Item	NZ2000
Control mode	Sensorless flux vector control (SFVC) Voltage/Frequency (V/F) control
Maximum frequency	Vector control: 0–320 Hz V/F control: 0–3200Hz
Carrier frequency	1–16 kHz The carrier frequency is automatically adjusted based on the load features.
Input frequency resolution	Digital setting: 0.01 Hz Analog setting: maximum frequency x 0.025%
Startup torque	G type: 0.5 Hz/150% (SFVC) P type: 0.5 Hz/100%
Speed range	1:100 (SFVC)
Speed stability accuracy	± 0.5% (SFVC)
Overload capacity	G type: 60s for 150% of the rated current, 3s for 180% of the rated current. P type: 60s for 120% of the rated current, 3s for 150% of the rated current.
Torque boost	Fixed boost Customized boost 0.1%–30.0%
V/F curve	Straight-line V/F curve Multi-point V/F curve N-power V/F curve (1.2-power, 1.4-power, 1.6-power, 1.8-power, square)
V/F separation	Two types: complete separation; half separation
Ramp mode	Straight-line ramp S-curve ramp Four groups of acceleration/deceleration time with the range of 0.0–6500.0s
DC braking	DC braking frequency: 0.00 Hz to maximum frequency Braking time: 0.0–100.0s Braking action current value: 0.0%–100.0%
JOG control	JOG frequency range: 0.00–50.00 Hz JOG acceleration/deceleration time: 0.0–6500.0s

Operation Instruction of NZ2000 Series Inverter

	Item	NZ2000
Standard functions	Onboard multiple preset speeds	It implements up to 16 speeds via the simple PLC function or combination of X terminal states
	Onboard PID	It realizes process-controlled closed loop control system easily.
	Auto voltage regulation (AVR)	It can keep constant output voltage automatically when the mains voltage changes.
	Overvoltage/ Overcurrent stall control	The current and voltage are limited automatically during the running process so as to avoid frequent tripping due to overvoltage/over current.
	Torque limit and control	It can limit the torque automatically and prevent frequent over current tripping during the running process.
	Instantaneous stop doesn't stop	The load feedback energy compensates the voltage reduction so that the AC drive can continue to run for a short time.
	Rapid current limit	It helps to avoid frequent over current faults of the AC drive.
	High performance	Control of asynchronous motor is implemented through the high-performance current vector control technology.
	Timing control	Time range: 0.0–6500.0 minutes
	Communication methods	RS485
	Running command channel	Given by the panel, control terminals, Serial communication port,can be switched by many ways
	Frequency source	10 kinds of frequency source,given by Digital analog voltage, analog current,Pulse, serial port.can be switched by many ways
	Auxiliary frequency source	10 kinds of Frequency source,can easily realize Micro adjustment,frequency Synthesizer
Input and output	Input terminals	6 digital input terminals, one of which supports up to 100 kHz high-speed pulse input (optional). 2 analog input terminal, one of which only supports 0–10 V voltage input and the other supports 0–10 V voltage input or 4–20 mA current input.
	Output terminal	1 digital output terminal 1 relay output terminal 1 analog output terminal :that supports 0–20 mA current output or 0–10 V voltage output

Item		NZ2000
operation on the operation panel	LED display	It displays the parameters.
	Key locking and function selection	It can lock the keys partially or completely and define the function range of some keys so as to prevent mis-function.
	Protection mode	Motor short-circuit detection at power-on, output phase loss protection, over-current protection, over-voltage protection, under voltage protection, overheat protection and overload protection.
Environment	Installation location	Indoor, avoid direct sunlight, dust, corrosive gas, combustible gas, oil smoke, vapour, drip or salt.
	Altitude	Lower than 1000m (Lower the grades when using higher than 1000m)
	Ambient temperature	-10°C ~40°C (Lower the grades if the ambient temperature is between 40°C and 50°C)
	Humidity	Less than 95%RH, without condensing
	Vibration	Less than 5.9 m/s ² (0.6 g)
	Storage temperature	-20°C~60°C

1.2 Description of Name Plate

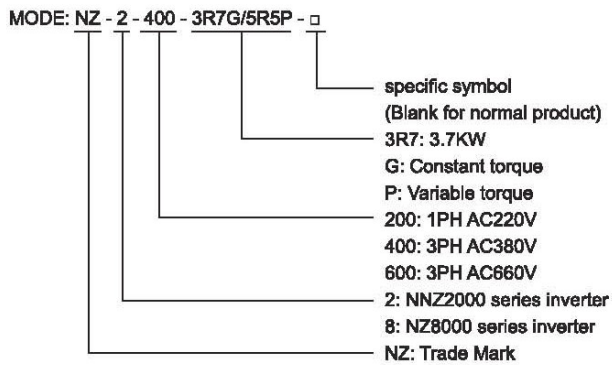

1.3 Selection Guide

1.3PH AC380V±15%/1PH AC220V±15%

Model	Rated Output Power (KW)	Rated Input current (A)	Rated Output Current (A)	Motor Power (kW)
1PH/3PH AC 220V -15%~15%				
NZ2200-0R4G	0.4	5.4	2.5	0.4
NZ2200-0R75G	0.75	7.2	5	0.75
NZ2200-1R5G	1.5	10	7	1.5
NZ2200-2R2G	2.2	16	11	2.2
NZ2200-3R7G	3.7	17	16.5	3.7
NZ2200-5R5G	5.5	21	25	5.5
NZ2200-7R5G	7.5	31	32	7.5
3PH AC380V±15%				
NZ2400-0R4G	0.4	3.4	1.2	0.4
NZ2400-0R75G	0.75	3.8	2.5	0.75
NZ2400-1R5G	1.5	5	3.7	1.5
NZ2400-2R2G	2.2	5.8	5	2.2
NZ2400-3R7G/5R5P	3.7/5.5	10/15	9/13	3.7/5.5
NZ2400-5R5G	5.5	15	13	5.5
NZ2400-7R5P	7.5	20	17	7.5
NZ2400-7R5G/11P	7.5/11	20/26	17/25	7.5/11
NZ2400-11G/15P	11/15	26/35	25/32	11/15
NZ2400-15G/18.5P	15/18.5	35/38	32/37	15/18.5
NZ2400-18.5G/22P	18.5/22	38/46	37/45	18.5/22
NZ2400-22G/30P	22/30	46/62	45/60	22/30
NZ2400-30G/37P	30/37	62/76	60/75	30/37
NZ2400-37G/45P	37/45	76/90	75/90	37/45
NZ2400-45G/55P	45/55	90/105	90/110	45/55
NZ2400-55G	55	105	110	55
NZ2400-75P	75	140	150	75
NZ2400-75G/90P	75/90	140/160	150/176	75/90
NZ2400-90G/110P	90/110	160/210	176/210	90/110

Chapter 1 Introduction

Model	Rated Output Power (KW)	Rated Input current (A)	Rated Output Current (A)	Motor Power (kW)
NZ2400-110G/132P	110/132	210/240	210/253	110/132
NZ2400-132G/160P	132/160	240/290	253/300	132/160
NZ2400-160G/185P	160/185	290/330	300/340	160/185
NZ2400-185G/200P	185/200	330/370	340/380	185/200
NZ2400-200G/220P	200/220	370/410	380/420	200/220
NZ2400-220G/250P	220/250	410/460	420/470	220/250
NZ2400-250G/280P	250/280	460/500	470/520	250/280
NZ2400-280G/315P	280/315	500/580	520/600	280/315
NZ2400-315G/350P	315/350	580/620	600/640	315/350
NZ2400-350G/400P	350/400	620/670	640/690	350/400
NZ2400-400G/450P	400/450	670/790	690/790	400/450
NZ2400-450G/500P	450/500	790/835	790/860	450/500

Chapter 2 Installation and wiring

2.1 Environment and installation requirements

Inverter's installation environment on the service life of inverter, and has direct influence on the normal function, Inverter can't satisfy the specification of environment , protection or fault could lead to the Inverter.

NZ2000 series inverter of wall hung inverter, please use the vertical installation so that the air convection and the heat dissipation effect can be better.

Inverter's installation environment, please make sure must comply with

- (01) - 10°C to + 40°C ambient temperature
- (02) Environment humidity 0 ~ 95% and no condensation
- (03) Avoid direct sunlight
- (04) Environment does not contain corrosive gas and liquid
- (05) Environment without dust, floating fiber, cotton and metal particles
- (06) Away from the radioactive material and fuel
- (07) Away from electromagnetic interference source (such as electric welding machine, big power machine)
- (08) Installed planar solid, no vibration, if it cannot avoid vibration, please add antivibration pads to reduce the vibration
- (09) Please install the inverter in the well ventilated place, easy to check and maintain, and install on the solid non-combustible material, away from the heating element (such as braking resistance, etc.)
- (10) Inverter installation please reserve enough space, especially many inverters' installation, please pay attention to the placement of the frequency Inverter, and configure cooling fans, make the environment temperature lower than 45°C.
- (11) Inverter can output the rated power when installed with altitude of lower than 1000m. It will be derated when the altitude is higher than 1000m.

(1) single inverter installation

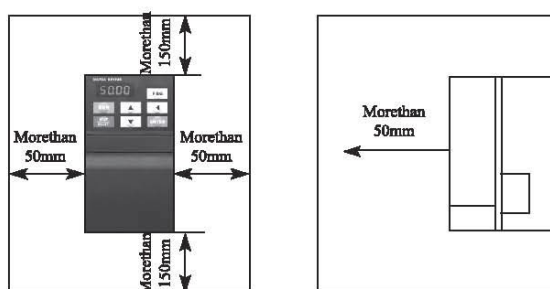

(2) Multiple inverters installed in one control cabinet.

Please pay attention:

① when encasing the multiple inverters, install them in parallel as a cooling measure.

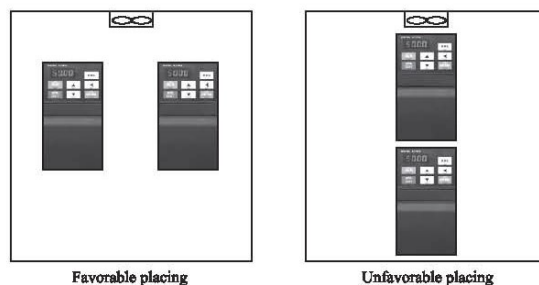

② If multiple inverters are installed in one control cabinet, please leave enough clearances and take cooling measure.

Operation Instruction of NZ2000 Series Inverter

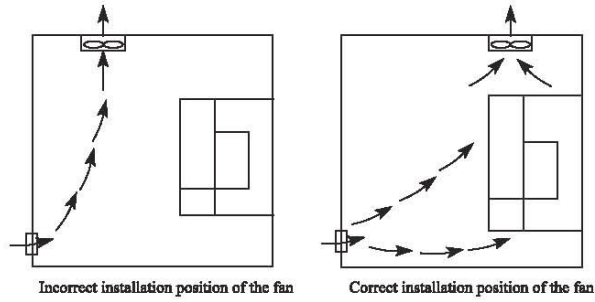

the inverter's outside shape and the installation dimensions

(1)0.4--22kW

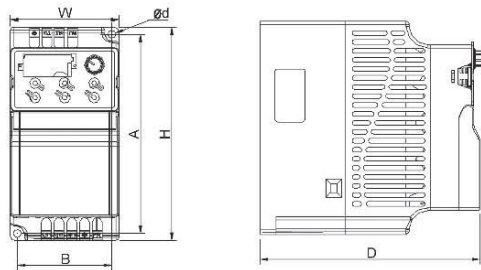

(2)30--160kW

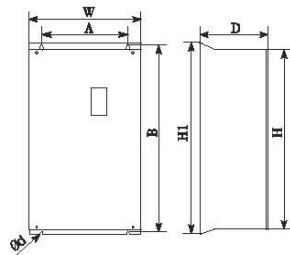

(3)185–450kW

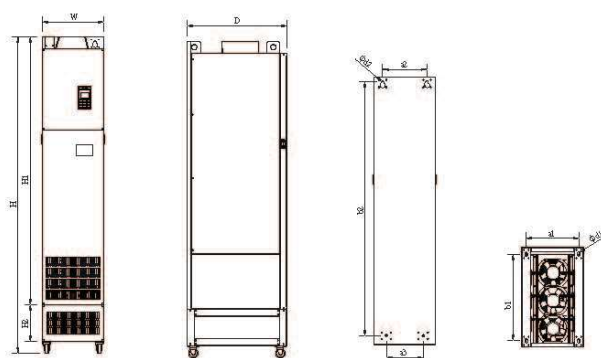

Model	Outline dimension(mm)				Installation size(mm)		
	W	H	H1	D	A	B	Φd
NZ2200-0R4G	72	142	—	152	62.7	132.7	5
NZ2200-0R75G							
NZ2200-1R5G							
NZ2200-2R2G	100	183	—	143	90	173	5
NZ2200-3R7G							
NZ2200-5R5G	130	260	—	184	120	250	5
NZ2200-7R5G							
NZ2400-0R4G	72	142	—	152	62.7	132.7	5
NZ2400-0R75G							
NZ2400-1R5G							
NZ2400-2R2G	100	183	—	143	90	173	5
NZ2400-3R7G/5R5P							
NZ2400-5R5G							
NZ2400-7R5P	130	260	—	184	120	250	5
NZ2400-7R5G/11P							
NZ2400-11G/15P							
NZ2400-15G/18.5P	195	280	—	179	182.5	266	7
NZ2400-18.5G/22P							
NZ2400-22G/30P							
NZ2400-30G/37P	245	390	425	193	180	410	7
NZ2400-37G/45P							

Operation Instruction of NZ2000 Series Inverter

Model	Outline dimension(mm)				Installation size(mm)		
	W	H	H1	D	A	B	Φd
NZ2400-45G/55P	300	500	540	252	200	522	9
NZ2400-55G							
NZ2400-75P							
NZ2400-75G/90P	338	546	576	256.5	270	560	9
NZ2400-90G/110P	338	550	580	300	270	564	9
NZ2400-110G/132P							
NZ2400-132G/160P	400	675	715	310	320	695	11
NZ2400-160G/185P							
NZ2400-132G/180PZ	400	871.5	915	310	320	895	11
NZ2400-160G/185PZ							

Model	Outline dimension(mm)					Installation size(mm)							
	W	D	H	H1	H2	a1	b1	d1	a2	a3	b2	d2	
NZ2400-185G/200P	300	500	1445	1180	200	250	430	14	220	150	1135	13	
NZ2400-200G/220P													
NZ2400-220G/250P													
NZ2400-250G/280P	330	545	1595	1330	200	280	475	14	220	185	1275	13	
NZ2400-280G/315P	325	545	1495	1230	200	275	470	14	225	185	1175	14	
NZ2400-315G/350P													
NZ2400-350G/400P	335	545	1720	1455	200	285	470	14	240	200	1380	14	
NZ2400-400G/450P													
NZ2400-450G/500P													

2.2 The opening size of the keyboard

- (1) 0.4–22kW 68.5mm*39mm
- (2) 30kW Or above 70mm*119mm

2.3 The Inverter Wiring

the inverter wiring of the main part and the control part

2.3.1 The inverter wiring of the main part

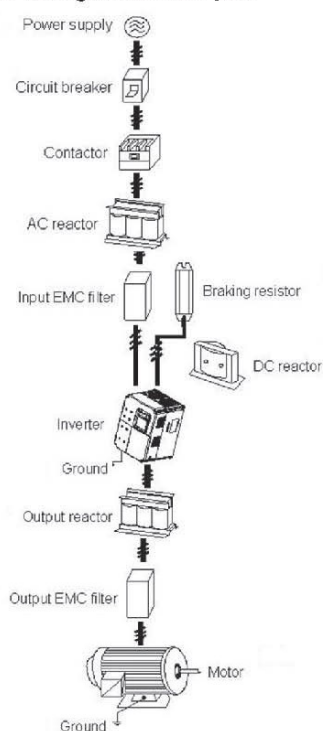

2.3.2 the descriptions of peripheral devices

(1)AC power supply

Use with in the permissible power supply specifications of the inverter.

(2)Moulded case circuit breaker:(MCCB)

When the power supply voltage is low or the input terminal short circuit occurs,the breaker can provide protection,during inspection,maintenance or the inverter is not running,you can cut off the breaker to separate the inverter from the power supply.

(3)Magnetic contractor(MC)

The contractor can turn on and turn off the power of the inverter to ensure safety.

(4)AC current reactor

a suppress high harmonic to protect the inverter to ensure safety.

(5)Brake resistor

When the motor is braking, the resistor can avoid DC bus high voltage of the inverter ,and improve the braking ability of the internal brake unit.

2.3.3 Precautions main circuit wiring

(1) circuit wiring ,refer to requirements of electrical codes.

(2)Application of supply power to output terminals(U,V,W)of the invert will damage it,so never perform such wiring.

(3)Power supply's wiring ,please use isolated wire and wire pipe if possible,and make isolated wire and wire pipe link to the earth.

(4)The inverter and welding device, high-power motor,high-power load can't use a earth cable.

(5) The ground terminal E,ground impedance is lower than 100Ω

(6)Use the shortest earth cable possible.

(7)Many inverters are earthed, pay attention not to cause ground loops.

(8)the power cables and the control cables must be separated in the main circuit. keep the power cables more than 10 cm away from the paralleled control cables,when the power cables and the control cables are crossed,make them vertical.Don't make the power cables and the control cables together, or the interference will cause.

(9)Under normal circumstances,the distance between the inverters and the motors is less than 30m,the current produced by the parasitic capacitance may cause over-current protection, mis-action,inverter's fault and equipment operating faults .The maximum distance is 100m,when the distance is long, please select the output side filter,and reduce the carrier frequency.

(10)Don't install an absorbing capacitor or other capacitance-resistance absorbing devices.

(11)Ensure the terminals are all locked tightly,the cables are connected well with the terminals,present the looseness due to an action of shaking,cause sparks and the short circuit

To minimize the interference,it is recommended that the contactor and relay should be connected to the surge absorber.

- Noise filter installed at the input side of inverter;
- Install noise isolation for other equipment by means of isolation transformer or power filter.

2.3.4 Device recommended specifications

Model	Motor Output (kW)	Main Circuit Cable Type (mm ²)	Breaker Selection (A)	Input Side Magnetic contractor (A)
1PH 220V 50/60Hz				
NZ2200-0R4G	0.4	0.75	10	9
NZ2200-0R75G	0.75	0.75	16	12
NZ2200-1R5G	1.5	1.5	25	18
NZ2200-2R2G	2.2	2.5	32	25
NZ2200-3R7G	3.7	2.5	40	32
NZ2200-5R5G	5.5	4.0	40	32
NZ2200-7R5G	7.5	6.0	50	38
3PH 380V 50/60HZ				
NZ2400-0R4G	0.4	0.75	6	9
NZ2400-0R75G	0.75	0.75	6	9
NZ2400-1R5G	1.5	0.75	10	9
NZ2400-2R2G	2.2	0.75	10	9
NZ2400-3R7G/5R5P	3.7/5.5	1.5	16	12
NZ2400-5R5G	5.5	2.5	20	18
NZ2400-7R5P	7.5	4	32	25
NZ2400-7R5G/11P	7.5/11	4	32	25
NZ2400-11G/15P	11/15	4	40	32
NZ2400-15G/18.5P	15/18.5	6	50	38
NZ2400-18.5G/22P	18.5/22	10	80	65
NZ2400-22G/30P	22/30	10	80	65
NZ2400-30G/37P	30/37	16	100	65
NZ2400-37G/45P	37/45	25	100	80
NZ2400-45G/55P	45/55	35	160	95
NZ2400-55G	55	50	160	115
NZ2400-75P	75	50	160	115
NZ2400-75G/90P	75/90	70	250	150
NZ2400-90G/110P	90/110	95	250	170
NZ2400-110G/132P	110/132	120	400	205
NZ2400-132G/160P	132/160	150	400	245
NZ2400-160G/185P	160/185	185	400	300
NZ2400-185G/200P	185/200	185	500	410

Operation Instruction of NZ2000 Series Inverter

Model	Motor Output (kW)	Main Circuit Cable Type (mm ²)	Breaker Selection (A)	Input Side Magnetic contractor (A)
NZ2400-200G/220P	200/220	185	500	410
NZ2400-220G/250P	220/250	240	630	410
NZ2400-250G/280P	250/280	240	630	475
NZ2400-280G/315P	280/315	150*2	700	620
NZ2400-315G/350P	315/350	185*2	800	620
NZ2400-350G/400P	350/400	185*2	800	620
NZ2400-400G/450P	400/450	240*2	1000	800
NZ2400-450G/500P	450/500	240*2	1000	800

*The above data are for reference only.

2.3.5 Main circuit terminals and description

1.Main circuit terminal arrangement NZ2000 series inverter is as follows:

Type a:3ph380v0.2-2.2kW&1ph220v0.4-1.5kW

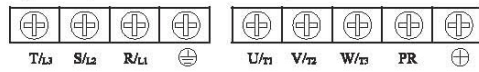

Type b:3ph380v3.7-5.5kW&1ph220v2.2-3.7kW

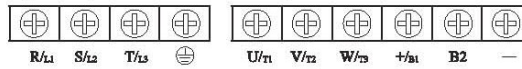

Type c:3ph380v7.5-11kW&1ph 220v 5.5-7.5kW

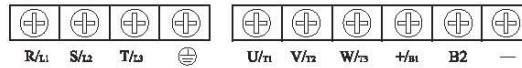

Type d:3ph 380v15-22kW

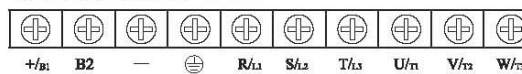

Type e:3ph 380v 30-37kW

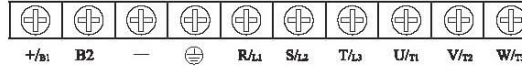

Chapter 2 Installation and wiring

Type f:3ph 380v 45-75kW

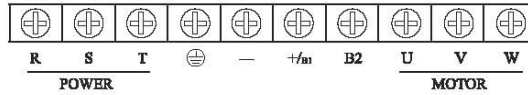

Type g:3ph 380v 90-110kW

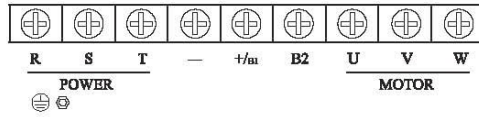

Type h:3ph 380v 132-160kW

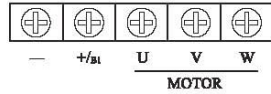
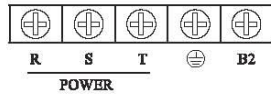

2. Description of main circuit terminals

Terminal Name	Description
R/L1、 S/L2、 T/L3	Connect to the commercial power supply.
U/T1、 U/T2、 U/T3	Inverter output terminals, connect a three-phase motor.
+/B1、 -	Positive and negative DC inverter, brake unit can be connected.
+/B1、 B2	Connect brake resistor.
+、 PR	
⊖	Earth (ground)

Note:For single-phase power input:
 from 0.75KW-1.5kW corresponds to R/L1, S/L2 terminals;
 from 2.2KW-3.7kW corresponds to S/L2, T/L3 terminals

3.Wiring Example

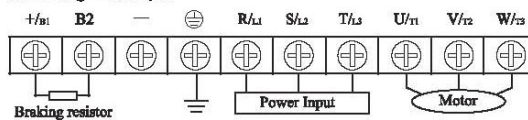

4.The basic wiring diagram

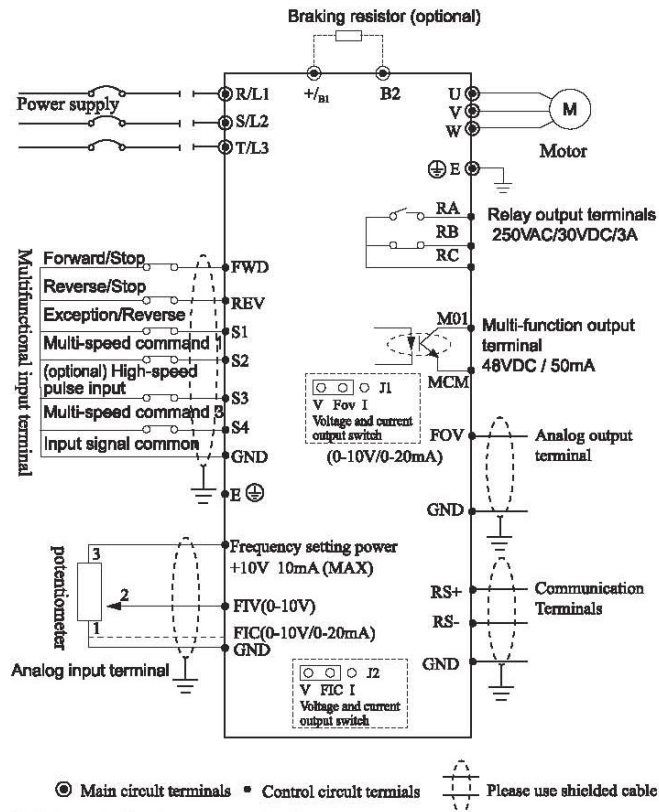

Note: For single-phase power input:
 from 0.75kW-1.5kW corresponds to R/L1, S/L2 terminals;
 from 2.2kW-3.7kW corresponds to S/L2, T/L3 terminals

2.4 Control Terminals

Control terminal arrangement

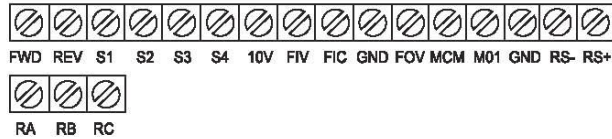

Note: 30kW or above , the product contains 24V terminal

2.4.1 Control Terminal Description

(1) Input signals

Terminal Name	Function Description	Remarks
FWD	Forward command input (multi-function input terminals)	Multi-function input terminals S1 ~ S4, FWD, REV terminals by reference number of specific settings, set the terminal and GND closed effective
REV	Reverse command input (multi-function input terminals)	
S1	Multi-function input terminals	
S2	Multi-function input terminals	
S3	High-speed pulse input terminal (optional)	
S4	Multi-function input terminals	
FOV	Analog output terminal	0~10V/0~20mA
10V	Frequency setting power	
FIV	Analog voltage input terminal	0~10V
FIC	Analog input terminal	0~20mA/0~10V
GND	Input signal common	
MCM	Optically coupled output common	
M01	Multifunctional optical coupling output contacts	
RS+	RS485 positive	RS485 communication
RS-	RS485 negative	
RA	Relay output contacts (normally open)	
RB	Relay output contacts (normally closed)	
RC	Relay output contacts RA, RB common	

Control panel switch Description:

Switch name	Switch Description
J2	Voltage (0 ~ 10V) / current (0 ~ 20mA) input switch V, FIC short for voltage input; I, FIC short for current input
J1	Voltage (0 ~ 10V) / current (0 ~ 20mA) output switch V and FOV shorted to voltage output; I and FOV shorting current output

Control loop distribution NOTES:

- (1) Please let the control signal lines and the main lines, and other power lines, power lines separate traces.
- (2) In order to prevent interference caused by malfunction, use stranded or double-stranded shielded wire line, specifications for 0.5 ~ 2mm²
- (3) Make sure that each using terminal to allow conditions, such as: power supply, the maximum current.
- (4) correct ground terminal E, grounding resistance is less than 100Ω.
- (5) each terminal's wiring requirements, the correct selection of accessories such as potentiometers, voltmeter, input power supplies.
- (6) After completing the wiring correctly and check to make sure it is correct and then the power can be on.

Chapter 3 Operation

3.1 Digital Operator Description

Digital Operator can also be called Panel

3.1.1 the picture of the panel

(1) 0.2–22kW





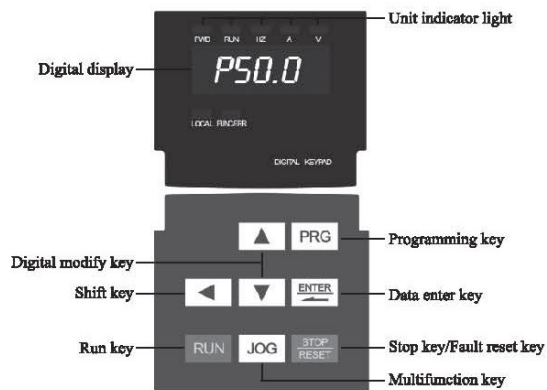





(2) 30kW or above



Note: If the keyboard needs to be equipped with an encoder or the keyboard is displayed in double row, please indicate the order.

3.1.2 the descriptions of the key's function

Key	Name	Description
	Programming key	Entry or escape of first-level menu
	Data enter key	Progressively enter menu and confirm parameters.
	UP Increment Key	Progressively increase data or function codes.
	DOWN Decrement Key	Progressive decrease data or function codes.
	Right shift Key	In parameter setting mode, press this button to select the bit to be modified. In other modes, cyclically displays parameters by right shift
	Run key	Start to run the inverter in keypad control mode.
	Stop key/Fault reset key	In running status, restricted by F7.02, can be used to stop the inverter. When fault alarm, can be used to reset the inverter without any restriction.
	Multifunction key	

3.1.3 Indicator light descriptions

Indicator Light Name	Indicator Light Description
Hz	Frequency unit
A	Current unit
V	Voltage unit
FWD/REV	Light off: forward operation. Light on: reverse operation.

3.2 Operational process

3.2.1 Parameter Settings

three-level menu :

- 1.The function code group (first menu);
- 2.Function code symbols (second menu);
- 3.Function code set value (third menu).

Explanation: the three-level menu operation, can press PRG or ENTER to return to the secondary menu.The difference between the two is: press ENTER to set parameters in control panel, and then return to the secondary menu, and automatically move to the next function code;Press PRG directly to return to the secondary menu, don't store parameters, and keep staying in the current function code.Example: change the function code P1.03 from 00.00 Hz change the sample set to 50.00 Hz.

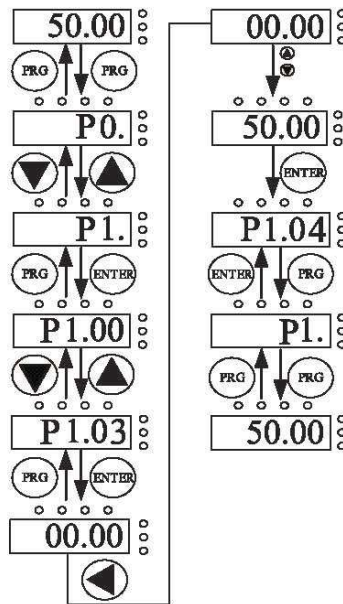

Flow chart of parameter setting.

In three-level state, if the parameter is not flashing, said the function code cannot be modified, possible reasons are:

- 1) The function code parameters can not be modified. Such as the actual testing parameters, operation records, etc.;
- 2) The function code in the running state cannot be modified, need to stop to modify;

3.2.2 Fault reset

After the failure of the inverter, the inverter will be prompted to related fault information. Users can press STOP key on the keyboard or terminal function to conduct the fault reset (P5), after fault reset, the inverter is in the standby state. If the inverter is in fault state, the user does not carry on the fault reset, the inverter is in the running to protect state, inverter can't run.

3.2.3 Motor parameter self learning

1: The dynamic parameter self learning

Choosing no PG vector control operation mode, input motor nameplate parameters must be accurate, inverter will based on nameplate parameters matching standard motor; In order to get better control performance, motor parameter auto-tuning is suggested and auto-tuning steps are as follows:

First will run command channel choice (P2.00) choice for keyboard commands. Then the actual parameters according to the motor, please input the following parameters.

P2.00: the motor type;

P2.01: the motor rated power;

P2.02: the motor rated voltage;

P2.03: the motor rated current;

P2.04: the motor rated frequency;

P2.05: the motor rated speed.

In the process of self learning, the keyboard will display "study", when the keyboard display END, the motor parameter self learning is end.

Note: in the process of auto-tuning, motor and load should be released, otherwise, the motor parameters obtained from the auto-tuning may not be correct.

2: the static parameters of the self learning

Motor static parameters auto-tuning, don't need to release motor with the load, motor parameter auto-tuning, must correct the

input parameters of motor nameplates (P2.01 - P2.05), since auto-tuning will detect the motor stator resistance and rotor resistance and leakage inductance of the motor. And mutual inductance of the motor and no-load current will not be able to measure, the user can input the corresponding values according to the motor nameplates.

3.3 Running state

3.3.1 Power-on initialization

In the process of the Inverter's power-on, the system first initializes, LED display for "2000", and seven lights all bright. After the initialization is complete, the drive is in standby mode.

3.3.2 Standby status

In the stopping or running status, can display a variety of state parameters. By Function Code P7.03 (operating parameters), P7.05 (stop parameter) binary bits, Various definitions can refer to P7.03 and P7.05 function code.

3.3.3 Motor parameters self-learning

Please refer to the detailed description of P2.37 a function code.

3.3.4 Running

In the running state, a total of sixteen can choose whether to display the status parameters are: operating frequency, set frequency, bus voltage, output voltage, output current, operating speed, output power, output torque, PID setting, PID FIV analog input voltage, analog input voltage FIC, the number of segments multi-speed, torque setpoint, whether to display the function code is decided by P7.03 and P7.04 bit (converted into binary) choice, press the key to switch the display order of the selected parameters, press the JOG key to left in order to switch the display selected parameters.

3.3.5 Failure

NZ2000 series offers a variety of fault information, please refer NZ2000 series inverter faults and their countermeasures.

3.4 Quick commissioning

Operation Instruction of NZ2000 Series Inverter

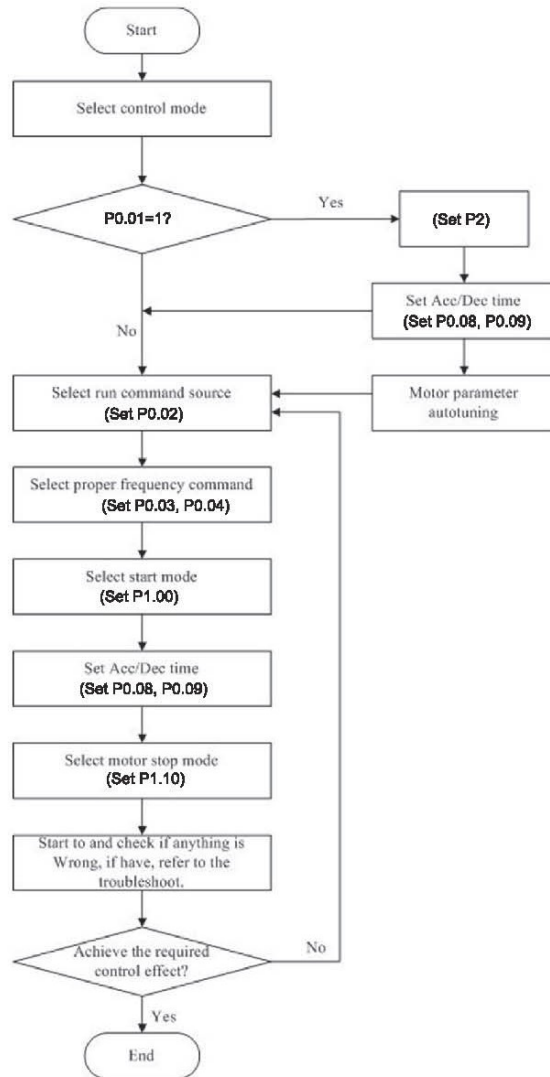

Chapter 4 Detailed Function Description

Group P0: Basic Parameters

P0.00	G/P type display		Default	Model dependent
	Setting Range	1	G type (constant torque load)	
		2	P type (variable torque load e.g. fan and pump)	

This parameter is used to display the delivered model and cannot be modified.

1: Applicable to constant torque load with rated parameters specified

2: Applicable to variable torque load (fan and pump) with rated parameters specified

P0.01	Control mode selection		Default	0
	Setting Range	0	Voltage/Frequency (V/F) control	
		1	Sensorless flux vector control (SFVC)	

0: Voltage/Frequency (V/F) control

It is applicable to applications with low load requirements or applications where one AC drive operates multiple motors, such as fan and pump

1: Sensorless flux vector control (SFVC)

It indicates open-loop vector control, and is applicable to high-performance control applications such as machine tool, centrifuge, wire drawing machine and injection moulding machine. One AC drive can operate only one motor.

Note: If vector control is used, motor auto-tuning must be performed because the advantages of vector control can only be utilized after correct motor parameters are obtained. Better performance can be achieved by adjusting the motor parameters.

Operation Instruction of NZ2000 Series Inverter

P0.02	Command channel selection		Default	0
	Setting Range	0	Operation panel control	
		1	Terminal control	
		2	Communication control	

It is used to determine the input channel of the AC drive control commands, such as run, stop, forward rotation, reverse rotation and jog operation. You can input the commands in the following three channels:

0: Operation of panel control

Commands are given by pressing keys RUN and STOP/RESET on the operation panel.

1: Terminal control

Commands are given by means of multifunctional input terminals with functions such as FWD, REV, JOGF, and JOGR.

2: Communication control (Modbus RTU)

Commands are given from host computer.

P0.03	Frequency source		Default	00
	Setting Range	Unit's digit (Frequency source)		
		0	Main frequency source X	
		1	X and Y operation (operation relationship determined by ten's digit)	
		2	Switchover between X and Y	
		3	Switchover between X and "X and Y" operation"	
		4	Switchover between Y and "X and Y" operation"	
		Ten's digit (X and Y operation)		
		0	X+Y	
		1	X-Y	
		2	Maximum of X and Y	
		3	Minimum of X and Y	

It is used to select the frequency setting channel. Through the main frequency source X and auxiliary frequency source Y compound to achieve a given frequency.

Unit's digit (Frequency source)

0: The main frequency X

The main frequency X as the target frequency.

1: Advocate complementary operation result as the target frequency, the operation relationship is decided by the function code "ten's digit".

2:Main frequency source X and auxiliary frequency source Y switch when the multifunctional input terminal 18 (frequency switch) is invalid, the main frequency X as the target frequency. When the multifunctional input terminals function 18 (frequency source switch) is valid, auxiliary frequency Y as the target frequency.

3:The main switch frequency source X and advocate complementary operation results When the multi-function input terminals function 18 (frequency switch) is invalid, the main frequency X as the target frequency. When the multi-function input terminals function 18 (frequency switch) is valid, advocate complementary computing results as the target frequency.

4:Auxiliary switch frequency source Y and advocate complementary operation results When the multi-function input terminals function 18 (frequency switch) is invalid, auxiliary frequency Y as the target frequency. When the multi-function input terminals function 18 (frequency switch) is valid, advocate main/auxiliary computing results as the target frequency.

Ten's digit : frequency source main/auxiliary relationship between operation:

0:The main frequency of X and Y auxiliary frequency and frequency as the target.

1:Main frequency X minus Y auxiliary frequency difference as the target frequency.

2:MAX (the main frequency source X, the auxiliary frequency source Y) take the main frequency absolute value of the largest in the X and Y auxiliary frequency as the target frequency.

3:MIN (the main frequency source X, the auxiliary frequency source Y) take the main frequency the least absolute value of X and Y auxiliary frequency as the target frequency. In addition, when the frequency source selection of the advocate complementary computing, offset frequency, can be set by P0.21 offset frequency, superimposed on the advocate complementary operation results in a flexible response to various needs.

Operation Instruction of NZ2000 Series Inverter

P0.04	Main frequency source X selection	Default	0
	Setting Range	0	Digital setting (P0.10 preset frequency, can modify the UP/DOWN, power lost don't memory)
1		Digital setting (P0.10 preset frequency, can modify the UP/DOWN, power lost memory)	
2		FIV	
3		FIC	
4		Reserved	
5		Pulse setting (S3)	
6		Multistage instruction	
7		PLC	
8		PID	
9		Communications given	

Choose inverter main input channel of a given frequency.

A total of 9 given frequency channels:

0: digital setting (power lost memory)

Set the initial value of frequency P0.10 (frequency preset) values. Can bring through a keyboard ▲ keys and ▼ keys (or multi-function input terminal of the UP and DOWN) to change the set frequency value of the inverter. Inverter after the power is off and the power is on again, set frequency values revert to P0.10 (digital frequency setting preset) values.

1: digital setting (power lost memory)

Set the initial value of frequency P010 (frequency preset) values. Can be brought by a keyboard ▲, ▼ keys (or multi-function input terminal of the UP and DOWN) to change the set frequency value of the inverter.

Inverter after the power is off and the power is on again, set frequency electric moment for the last set, through the keyboard bring ▲, ▼ keys or terminal correction by the memory of UP and DOWN.

What need to remind is, P0.23 set for "digital frequency setting down memory selection", P0.23 is used to select the inverter when the inverter stops, P0.23 is used to select whether inverter memorizes the freq or is reset during stopping time, P0.23 is related to the stop, isn't related to the drop memory, pay attention in the application.

2: FIV

3: FIC

4: Reserved

NZ2000 panel provides two analog input terminal (FIV, FIC). Among them, the FIV is from 0V to 10V voltage input, FIC is from 0V to 10V voltage input, can also be used for 4 ~ 20 mA current input, FIV, FIC of the input voltage value, the corresponding relationship with the target frequency, users are free to choose. NZ2000 provide 5 set of corresponding relation curve, three groups of curve for linear relationship (2 point correspondence), three groups of curve for linear relationship (4 point correspondence), the user can set through the P5 group and C6 group function code .

P5.33 function code is used to set the FIV ~ the FIC two-way analog input, respectively select which of the five groups of curves, five specific corresponding relation curves, please refer to the descriptions of P5, C6 group function code.

5: Pulse frequency (S3) given is given by terminal pulse. Pulse signal given specifications: voltage range of 9v~ 30v and frequency range of from 0 KHZ to 100 KHZ. Input pulse can only be given from multifunctional input terminals S3.

S3 terminal input pulse frequency and the corresponding set of relations, through the P5.28 ~ P5.31 setting, the corresponding relations between for 2 linear point correspondence .the linear relation between the corresponding set of input pulses 100.0%, refer to the relative maximum frequency P0.12 percentage.

6: More instructions to choose and more instructions operation mode: select speed through the digital input S terminal state of different combinations, NZ2000 can set up 4 multispeed instruction terminals and select 16 state of those terminals. Through the function of the PC group code corresponding to any 16 Multistage instruction .The Multistage instruction is referred to the percentage of the maximum frequency P0.12

Digital input terminal function S terminal as multispeed selection terminal need to be done in group P5 corresponding settings, please refer to the specific content P5 group of related function parameters.

7: Simple PLC

When frequency source is in simple PLC mode, frequency source of inverter can run between any frequency source from 1 to 16 , the hold time from 1 to 16 frequency instruction and their respective acc.

/dec. time can also be set by the user. The specific content can refer to PC group.

8: PID

Select the process of PID control output as the operating frequency. Commonly used in the scene of the closed loop control technology, such as constant pressure closed loop control, constant tension closed-loop control, etc. Application of PID as frequency source, you need to set up "PID" PA group related parameters.

9: Communication given

the main frequency source is given by the upper machine through the way of communication. NZ2000 support communication methods: RS - 485.

P0.05	Auxiliary frequency source Y selection	Default	0
	Setting Range	0	digital setting (P0.10 preset frequency, can modify the UP/DOWN, power lost don't memory)
1		digital setting (P0.10 preset frequency, can modify the UP/DOWN, power lost memory)	
2		FIV	
3		FIC	
4		Reserved	
5		Pulse setting (S3)	
6		Multistage instruction	
7		PLC	
8		PID	
9		Communications given	

Auxiliary frequency source with the frequency for a given channel as an independent (i.e. frequency source selection of X to Y switch), its usage and the main frequency source with X, using the method can be refer to P0.04 related instructions.

When auxiliary frequency source used as a superposition of a given (i.e. frequency source selection of X + Y, X to X + Y switch or Y to X + Y), the need to pay attention to:

1) When the auxiliary frequency source for digital timing, preset frequency (P0.10) doesn't work, the user through the keyboard bring ▲, ▼ button (or multi-function input terminal of UP and DOWN) on the frequency of adjustment, directly in the main on the basis of a given frequency adjustment.

2) When the auxiliary frequency source for analog input given (FIV, FIC) or to the input pulse given, 100% of the input set corresponding auxiliary frequency source range, can be set by P0.06 and P0.07.

3) 3) When Frequency source is pulse input given similar to analog given. Tip: auxiliary frequency source selection and main frequency source X, Y can't set to the same channel, namely P0.04 and P0.05 can't set to the same value, otherwise it will be easy to cause confusion.

P0.06	Auxiliary frequency source superposition Y range selection	Default	0
	Setting Range	0 1	Relative to the maximum frequency Relative to the main frequency source X
P0.07	Auxiliary frequency source superposition Y	Default	0
	Setting Range	0%~150%	

When selecting frequency source for the superposition of "frequency" (P0.03 set to 1, 3, or 4), these two parameters are used to determine the adjusting range of auxiliary frequency source.

P0.05 is used to determine the scope of the auxiliary frequency source of the object, the choice of relative to the maximum frequency, can also be relative to the rate of frequency source X, if choice is relative to the main frequency source, the scope of the secondary frequency source will change as the change of main frequency X.

P0.08	Acceleration time 1	Default	Model dependent
	Setting Range	0.00s~65000s	
P0.09	Deceleration time 1	Default	Model dependent
	Setting Range	0.00s~65000s	

Acceleration time refers to the inverter from zero, the deceleration time needed for reference frequency (P0.24 determine).

Deceleration time refers to the inverter from benchmark frequency (P0.24 determine), deceleration down to zero frequency time required.

P0.10	Frequency preset	Default	50.00Hz
	Setting Range	0.00 ~ maximum frequency (P0.12)	

When frequency source selection set for "digital" or "terminal UP/DOWN", the function code value is the frequency of the inverter digital set initial value.

Operation Instruction of NZ2000 Series Inverter

P0.11	Rotation direction	Default	0
	Setting Range	0	Same direction
		1	Reverse direction

By changing the function code, need not to change the motor wiring for the purpose of the motor's direction, its effect is equivalent to adjust electric machine (U, V, W) any two lines for motor direction of rotation transformation.

Tip: after initialization, parameters will restore the original state of the motor running direction. Pay attention to the good debugging system which is forbidden to change the motor's running direction.

P0.12	Maximum frequency	Default	50.00Hz
	Setting Range	50.00Hz~320.00Hz	

In NZ2000 analog input and pulse input (S3), period of instruction, etc., as a frequency source 100.0% of their relatively P0.12 calibration.

NZ2000 maximum frequency output can reach 3200 Hz, instructions for both frequency resolution and the frequency range of input two refers to the standard, can choose frequency instruction through P0.22 decimal digits.

When P0.22 is selected to 1, the frequency resolution of 0.1 Hz, the P0.12 set range 50.0 Hz ~ 3200.0 Hz;

When P0.22 is selected to 2, the frequency resolution of 0.01 Hz, the P0.12 set range 50.00Hz ~ 320.00 Hz;

P0.13	Upper limit frequency source	Default	0
	Setting Range	0	P0.12 setting
		1	FIV
		2	FIC
		3	Reserved
		4	PULSE settings
		5	communication settings

Define the upper limit frequency source the upper limit frequency can be from digital set (P0.12), also can from the analog input. When was capped with analog input frequency, analog input corresponding set 100% is corresponding to P0.12.

For example at the scene of the winding control using torque control mode, in order to avoid material break appear "ride" phenomenon, can use analog frequency cap, when the inverter runs to the upper limit frequency value, the inverter is in a maximum frequency operation.

Chapter 4 Detailed Function Description

P0.14	Upper limit frequency	Default	50.00Hz
	Setting Range	Frequency lower limit P0.16~Maximum frequency P0.12	
P0.15	Upper limit frequency offset	Default	0.00Hz
	Setting Range	0.00Hz~Maximum frequency P0.12	

When the upper limit set for analog or PULSE frequency, P0.15 as the set point offset, superimpose the offset frequency and P0.14 setting upper limit frequency values, as the final limit frequency value.

P0.16	Frequency lower limit	Default	0.00Hz
	Setting Range	0.00Hz~Upper limit frequency P0.14	

Frequency instructions below P0.16 set the lower limit of frequency, inverter can stop and run at the lower frequency or a ship at zero speed line, what operation mode can be P8.14 (set frequency is lower than the lower limit frequency operation mode) Settings.

P0.17	Carrier frequency	Default	Model dependent
	Setting Range	1kHz~16.0kHz	

This function adjusting carrier inverter. By adjusting the carrier frequency can reduce electrical noise, to avoid the resonance point of mechanical system, reduce the line of floor drain current and reducing interference caused by inverter.

When the carrier frequency is low, the output current of higher harmonic component increases, motor loss increases, the motor temperature increases. When the carrier frequency is higher, the motor loss is reduces, the motor temperature rise reduces, but the loss of the inverter increases, the temperature rise of the inverter increases, increased interference.

Adjusting the carrier frequency will affect the performance of the following:

Carrier frequency	low → high
The motor noise	large → small
The output current waveform	Bad → good
Temperature Rise in Electric Motors	High → low
The temperature rise of the inverter	Low → high
leak current	Small → large
Foreign raXated interference	Small → large

Different power inverter, the carrier frequency of the factory Settings is different. Although the user can according to need to modify, but

Operation Instruction of NZ2000 Series Inverter

need to pay attention: if the carrier frequency set to a higher value than the factory, will lead to inverter radiator temperature increase, the user needs to use of inverter derating, otherwise the inverter is in danger of overheating alarm.

P0.18	Carrier frequency adjustment with temperature	Default	1
	Setting Range	0: No 1: Yes	

Carrier frequency with the temperature adjustment, is refers to the inverter is detected its radiator at high temperature, reduce the carrier frequency automatically, for lowering the temperature rise of the inverter. When the radiator at low temperature, carrier frequency returning to the set value. This feature can reduce overheat alarm of inverter.

P0.19	Acceleration/Deceleration time unit	Default	1
	Setting Range	0	1s
		1	0.1s
		2	0.01s

To meet the needs of all kinds of scene, NZ2000 provides three kinds of deceleration time units, 1 seconds, 0.1 seconds, respectively, and 0.01 seconds.

Note: Modify the function parameters, four groups of decimal digits, as suggested by the deceleration time will change, the corresponding deceleration time changes, also pay special attention to in the course of application.

P0.21	Frequency offset of auxiliary frequency source for X and Y operation	Default	0.00Hz
	Setting Range	0.00Hz~Maximum frequency P0.12	

This function code is only valid at the time of frequency source selection of the advocate complementary computing.

When frequency source of the advocate complementary computing P0.21 as offset frequency, and advocate complementary computing results superposition frequency value, as the final frequency setting, make frequency setting be more flexible.

P0.22	Frequency reference	Default	2
	Setting Range	1	0.1Hz
		2	0.01Hz

Chapter 4 Detailed Function Description

All the parameters used to determine the resolution of the function code associated with the frequency.

When the frequency resolution of 0.1 Hz, NZ2000 maximum output frequency can reach 3200 Hz, and the frequency resolution of 0.01 Hz, NZ2000 maximum output frequency of 320.00 Hz.

Note: Modify the function parameters, all related to the frequency parameters of decimal digits will change, the corresponding frequency values also produces change, pay special attention in the applications.

P0.23	Retentive of digital setting frequency upon power	Default	0
	Setting Range	0	No memory
		1	Memory

The function of frequency source for digital only effective when setting.

"No memory" refers to the inverter after downtime, digital frequency values revert to P0.10(frequency preset)value, the keyboard bring ▲, ▼ button or terminal is UP and DOWN to correct the frequency is reset.

"Memory" refers to the inverter after downtime , digital set frequency keep set for the last moment of downtime, bring about keyboard ▲, ▼ button or terminal is UP and DOWN to correct the frequency of remain valid.

P0.24	Acceleration/Deceleration time base frequency	Default	0
	Setting Range	0	Maximum frequency (P0.12)
		1	Set frequency
		2	100Hz

Acceleration/Deceleration time, refers to the frequency from zero to P0.24 set frequency between the Acceleration/Deceleration time. When the P024 is selected to 1, deceleration time is associated with a set frequency, if set frequency change frequently, the acceleration of the motor is variable, pay attention to the application.

P0.25	Base frequency for UP/DOWN modification during running	Default	0
	Setting Range	0	Running frequency
		1	Set frequency

This parameter is only valid when frequency source for the digital setting.

Used to determine the bring ▲, ▼ button or terminal of the keyboard UP/DOWN action, adopt what way set frequency correction, the target frequency is based on the operating frequency, increase or decrease or based on a set frequency increase or decrease. Two set of distinction, evident when inverter in the deceleration process, namely, if the operation of the inverter frequency and setting frequency is not at the same time, the parameter of the different selection difference is very big.

P0.26	Binding command source to frequency source		Default	000
	Setting Range	Unit's digit	Binding operation panel command to frequency source	
		0	No binding	
		1	Frequency source by digital setting	
		2	FIV	
		3	FIC	
		4	Reserved	
		5	Pulse setting (S3)	
		6	Multi-reference	
		7	Simple PLC	
		8	PID	
	9	Communication setting		
	Ten's digit	Binding terminal command to frequency source(0~9, same as unit's digit)		
	Hundred's digit	Binding communication command to frequency source(0~9, same as unit's digit)		

It is used to bind the three running command sources with the nine frequency sources, facilitating to implement synchronous switchover.

For details on the frequency sources, see the description of P0.04 (Main frequency source X selection). Different running command sources can be bound to the same frequency source.

If a command source has a bound frequency source, when the process of frequency source is effective, the command source set in P003 to P007 will no longer work.

P0.27	Communication expansion card type	Default	0
	Setting Range	0	Modbus communication card

Group P1:Start/Stop Control

P1.00	Start mode	Default	0
	Setting Range	0	direct start
		1	Rotational speed tracking restart
	2	Pre-excited start (asynchronous motor)	

0: direct start

If the DC braking time is set to 0, the AC drive starts to run at the startup frequency. If the DC braking time is not 0, the AC drive performs DC braking first and then starts to run at the startup frequency. It is applicable to small-inertia load application where the motor is likely to rotate at startup.

1: Rotational speed tracking restart

The AC drive judges the rotational speed and direction of the motor first and then starts at the tracked frequency. Such smooth start has no impact on the rotating motor. It is applicable to the restart upon instantaneous power failure of large-inertia load. To ensure the performance of rotational speed tracking restart, set the motor parameters in group P2 correctly.

2: Pre-excited start (asynchronous motor)

It is valid only for asynchronous motor and used for building the magnetic field before the motor runs. For pre-excited current and pre-excited time, see parameters of P1.05 and P1.06. If the pre-excited time is 0, the AC drive cancels pre-excitation and starts to run at startup frequency. If the pre-excited time is not 0, the AC drive pre-excites first before starting, improving the dynamic response of the motor.

P1.01	Rotational speed tracking mode	Default	0
	Setting Range	0	Start from stop frequency
		1	From zero speed
	2	From maximum frequency	

To complete the rotational speed tracking process within the shortest time, select the proper mode in which the AC drive tracks the motor rotational speed.

0: From frequency at stop to track down.

It is the commonly selected mode.

1: From zero frequency to track down.

It is applicable to restart after a long time of power failure.

2: From the maximum frequency to track down.

It is applicable to the power-generating load.

P1.02	Rotational speed tracking speed	Default	20
	Setting Range	1~100	

In the rotational speed tracking restart mode, select the rotational speed tracking speed. The larger the value is, the faster the tracking is. However, too large setting value may cause unreliable Tracking.

P1.03	Startup frequency	Default	0.00Hz
	Setting Range	0.00Hz~10.00Hz	
P1.04	Startup frequency holding time	Default	0.0s
	Setting Range	0.0s~100.0s	

To ensure the motor torque at AC drive startup, set a proper startup frequency. In addition, to build excitation when the motor starts up, the startup frequency must be held for a certain time.

The startup frequency (P1.03) is not restricted by the frequency lower limit. If the set target frequency is lower than the startup frequency, the AC drive will not start and stays in the standby state. During switchover between forward rotation and reverse rotation, the startup frequency holding time is disabled. The holding time is not included in the acceleration time but in the running time of simple PLC.

Example 1:

P0.04=0 The frequency source is digital setting.

P0.10=2.00Hz The digital setting frequency is 2.00 Hz.

P1.03=5.00Hz The startup frequency is 5.00 Hz.

P1.04=2.0s The startup frequency holding time is 2.0s.

In this example, the AC drive stays in the standby state and the output frequency is 0.00 Hz.

Example 2:

P0.04=0 The frequency source is digital setting.

P0.10=10.00Hz The digital setting frequency is 10.00 Hz.

P1.03=5.00Hz The startup frequency is 5.00 Hz.

P1.04=2.0s The startup frequency holding time is 2.0s.

In this example, the AC drive accelerates to 5.00 Hz, and then accelerates to the set frequency 10.00 Hz after 2s.

P1.05	Startup DC braking current/Pre-excited current	Default	0%
	Setting Range	0%~100%	

Chapter 4 Detailed Function Description

P1.06	Startup DC braking time/Pre-excited time	Default	0.0s
	Setting Range	0.0s~100.0s	

Startup DC braking is generally used during restart of the AC drive after the rotating motor stops. Pre-excitation is used to make the AC drive build magnetic field for the asynchronous motor before startup to improve the responsiveness.

Startup DC braking is valid only for direct start. In this case, the AC drive performs DC braking at the set startup DC braking current. After the startup DC braking time, the AC drive starts to run. If the startup DC braking time is 0, the AC drive starts directly without DC braking. The larger the startup DC braking current is, the larger the braking force is.

If the startup mode is pre-excited start, the AC drive builds magnetic field based on the set pre-excited current. After the pre-excited time, the AC drive starts to run. If the pre-excited time is 0, the AC drive starts directly without pre-excitation. The startup DC braking current or pre-excited current is a percentage relative to the base Value.

If the rated motor current is less than or equal to 80% of the rated AC drive current, the base value is the rated motor current. If the rated motor current is greater than 80% of the rated AC drive current, the base value is 80% of the rated AC drive current.

P1.07	Acceleration/Deceleration mode	Default	0
	Setting Range	0	Linear acceleration/deceleration
		1	S-curve acceleration/deceleration A
	2	S-curve acceleration/deceleration B	

It is used to set the frequency change mode during the AC drive start and stop process.

0: Linear acceleration/deceleration

The output frequency increases or decreases in linear mode. The NZZ2000 provides four group of acceleration/deceleration time, which can be selected by using P5.00 to P5.08.

1: S-curve acceleration/deceleration A

The output frequency is incremented or decremented according to the S curve. S curve requires gentle start or stop the use of venues, such as elevators, conveyor belts and so on. Function Code P1.08 and P1.09, respectively, define the proportion of S-curve acceleration and deceleration time of the initial segment and the end of the period.

2: S-curve acceleration/deceleration B

In this curve, the rated motor frequency is always the inflexion point. This mode is fb usually used in applications where acceleration/deceleration is required at the speed higher than the rated frequency.

When the set frequency is higher than the rated frequency, the acceleration/deceleration time is:

$$t = \left(\frac{4}{9} * \left(\frac{f}{f_b} \right) + \frac{5}{9} \right) * T$$

In the formula, f is the set frequency, fb is the rated motor frequency and T is the acceleration time from 0 Hz to the rated frequency fb.

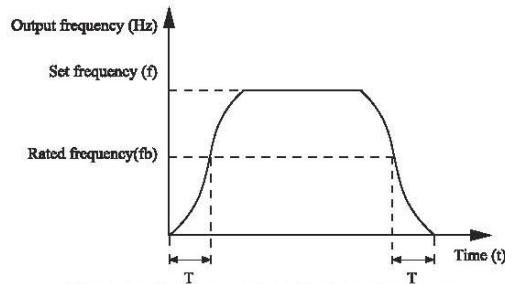

Figure 4-1 S-curve acceleration/deceleration B

P1.08	Time proportion of S-curve start segment	Default	30.0%
	Setting Range	0.0%~(100.0%-P1.09)	
P1.09	Time proportion of S-curve end segment	Default	30.0%
	Setting Range	0.0%~(100.0%-P1.08)	

These two parameters respectively define the time proportions of the start segment and the end segment of S-curve acceleration/deceleration A. They must satisfy the requirement:

$$P1.08 + P1.09 \leq 100.0\%$$

In Figure 4-2, t1 is the time defined in P1.08, within which the slope of the output frequency change increases gradually. t2 is the time defined in P1.09, within which the slope of the output frequency change gradually decreases to 0. Within the time between t1 and t2, the slope of the output frequency change remains unchanged, that is, linear acceleration/deceleration.

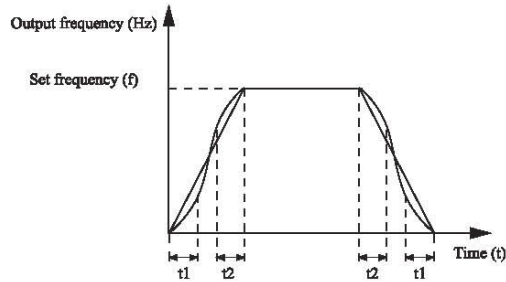

Figure 4-2 S-curve acceleration/deceleration A

P1.10	Stop mode	Default	0
	Setting Range	0	Decelerate to stop
		1	Coast to stop

0: Decelerate to stop

After the stop command is enabled, the AC drive decreases the output frequency according to the deceleration time and stops when the frequency decreases to zero.

1: Coast to stop

After the stop command is enabled, the AC drive immediately stops the output. The motor will coast to stop based on the mechanical inertia.

P1.11	Initial frequency of stop DC braking	Default	0.00Hz
	Setting Range	0.00Hz~Maximum frequency	
P1.12	Waiting time of stop DC braking	Default	0.0s
	Setting Range	0.0s~36.0s	
P1.13	Stop DC braking current	Default	0%
	Setting Range	0%~100%	
P1.14	Stop DC braking time	Default	0.0s
	Setting Range	0.0s~36.0s	

P1.11 (Initial frequency of stop DC braking)

During the process of decelerating to stop, the AC drive starts DC braking when the running frequency is lower than the value set in P1.11.

P1.12 (Waiting time of stop DC braking)

When the running frequency decreases to the initial frequency of

stop DC braking, the AC drive stops output for a certain period and then starts DC braking. This prevents faults such as over current caused due to DC braking at high speed.

P1.13 (Stop DC braking current)

This parameter specifies the output current at DC braking and is a percentage relative to the base value. If the rated motor current is less than or equal to 80% of the rated AC drive current, the base value is the rated motor current. If the rated motor current is greater than 80% of the rated AC drive current, the base value is 80% of the rated AC drive current.

P1.14 (Stop DC braking time)

This parameter specifies the holding time of DC braking. If it is set to 0, DC braking is cancelled. The stop DC braking process is shown in the following figure.

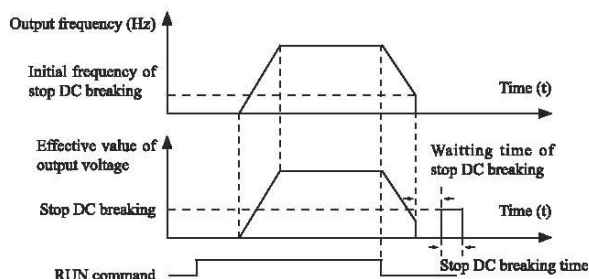

Figure 4-3 Stop DC braking process

P1.15	Brake use ratio	Default	100%
	Setting Range	0%~100%	

It is valid only for the AC drive with internal braking unit and used to adjust the duty ratio of the braking unit. The larger the value of this parameter is, the better the braking result will be. However, too larger value causes great fluctuation of the AC drive bus voltage during the braking process.

Group P2: Motor Parameters

P2.00	Motor type selection	Default	0
	Setting Range	0: Common asynchronous motor 1: Variable frequency asynchronous motor	

Chapter 4 Detailed Function Description

P2.01	Rated motor power	Default	Model dependent
	Setting Range	0.1kW~30.0kW	
P2.02	Rated motor voltage	Default	Model dependent
	Setting Range	1V~2000V	
P2.03	Rated motor current	Default	Model dependent
	Setting Range	0.01A~655.35A	
P2.04	Rated motor frequency	Default	Model dependent
	Setting Range	0.01Hz~Maximum frequency	
P2.05	Rated motor rotational speed	Default	Model dependent
	Setting Range	1rpm~65535rpm	

Set the parameters according to the motor's nameplate no matter whether V/F control or vector control is adopted. To achieve better V/F or vector control performance, motor auto-tuning is required. The motor auto-tuning accuracy depends on the correct setting of motor nameplate parameters.

P2.06	Stator resistance (asynchronous motor)	Default	Model dependent
	Setting Range	0.001Ω~30.000Ω	
P2.07	Rotor resistance (asynchronous motor)	Default	Model dependent
	Setting Range	0.001Ω~65.535Ω	
P2.08	Leakage inductive reactance (asynchronous motor)	Default	Model dependent
	Setting Range	0.01mH~655.35mH	
P2.09	Mutual inductive reactance (asynchronous motor)	Default	Model dependent
	Setting Range	0.1mH~6553.5mH	
P2.10	No-load current (asynchronous motor)	Default	Model dependent
	Setting Range	0.01A~P2.03	

The parameters in P2.06 to P2.10 are asynchronous motor parameters.

P2.06~ P2.10 parameters are ordinary unavailable on the motor's nameplate and are obtained by means of inverter's auto-tuning. Asynchronous motor's stationary auto-tuning can obtain only P2.06 to P2.08 three parameters. Asynchronous motor's dynamic auto-tuning can obtain besides all the parameters in P2.06 to P2.10, and can also obtain encoder phase sequence and current loop PI.

Each time "Rated motor power" (P2.01) or "Rated motor voltage" (P2.02) is changed, the AC drive automatically restores values of P2.06 to P2.10 to the parameter setting for the common standard Y series asynchronous motor.

If it is impossible to perform asynchronous motor's stationary auto-tuning manually input the values of these parameters according to data provided by the motor manufacturer.

P2.11-P2.36 Reserved

P2.37	Auto-tuning selection	Default	0
	Setting Range	0	No auto-tuning
		1	Asynchronous motor static auto-tuning
	2	Asynchronous motor complete auto-tuning	

0: No auto-tuning

Auto-tuning is prohibited.

1: Asynchronous motor static auto-tuning

It is applicable to scenarios where complete auto-tuning cannot be performed because the asynchronous motor can't be easily disconnected to the load.

Before performing static auto-tuning, properly set the motor type and motor nameplate parameters of P2.00 to P2.05 first. The AC drive will obtain three parameters of P2.06 to P2.08 by static auto-tuning. Action description: Set this parameter to 1, and press RUN. Then, the AC drive starts static auto-tuning.

2: Asynchronous motor complete auto-tuning

To perform this type of auto-tuning, ensure that the motor is disconnected to the load. During the process of complete auto-tuning, the AC drive performs static auto-tuning first and then accelerates to 80% of the rated motor frequency within the acceleration time set in P0.08. The AC drive keeps running for a certain period and then decelerates to stop within deceleration time set in P0.09. Set this parameter to 2, and press RUN. Then, the AC drive starts complete auto-tuning.

Note: Motor auto-tuning can be performed only in operation panel mode.

Group P3: Vector Control Parameters

P3 group function code applies only to the vector control, control of V/F is invalid.

Chapter 4 Detailed Function Description

P3.00	Speed loop proportional gain 1	Default	30
	Setting Range	1~100	
P3.01	Speed loop integral time 1	Default	0.50s
	Setting Range	0.01s~10.00s	
P3.02	Switchover frequency 1	Default	5.00Hz
	Setting Range	0.00~P3.05	
P3.03	Speed loop proportional gain 2	Default	20
	Setting Range	0~100	
P3.04	Speed loop integral time 2	Default	1.00s
	Setting Range	0.01s~10.00s	
P3.05	Switchover frequency 2	Default	10.00Hz
	Setting Range	P3.02~maximum output frequency	

Speed loop PI parameters vary with running frequencies of the AC drive.

If the running frequency is less than or equal to "Switchover frequency 1" (P3.02), the speed loop PI parameters are P3.00 and P3.01.

If the running frequency is equal to or greater than "Switchover frequency 2" (P3.05), the speed loop PI parameters are P3.03 and P3.04.

If the running frequency is between P3.02 and P3.05, the speed loop PI parameters are obtained from the linear switchover between the two groups of PI parameters, as shown in Figure 4-4

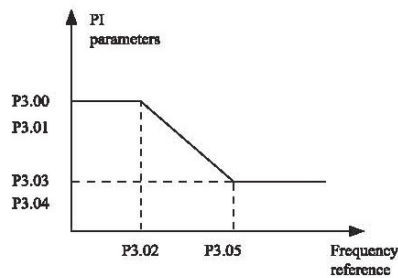

Figure 4-4 Relationship between running frequency and PI parameters

The speed dynamic response characteristics in vector control can be adjusted by setting the proportional gain and integral time of the speed regulator.

To achieve a faster system response, increase the proportional gain and reduce the integral time. Be aware that this may lead to system oscillation.

The recommended adjustment method is as follows:

If the factory setting cannot meet the requirements, make proper adjustment. Increase the proportional gain first to ensure that the system does not oscillate, and then reduce the integral time to ensure that the system has quick response and small overshoot.

Note: Improper PI parameter setting may cause too large speed overshoot, and overvoltage fault may even occur when the overshoot drops.

P3.06	Vector control slip gain	Default	100%
	Setting Range	50%~200%	

For SFVC, it is used to adjust speed stability accuracy of the motor. When the motor with load runs at a very low speed, increase the value of this parameter; when the motor with load runs at a very large speed, decrease the value of this parameter.

P3.07	Time constant of speed loop filter	Default	0.000s
	Setting Range	0.000s~0.100s	

In the vector control mode, the output of the speed loop regulator is torque current reference. This parameter is used to filter the torque references. It need not be adjusted generally and can be increased in the case of large speed fluctuation. In the case of motor oscillation, decrease the value of this parameter properly. If the value of this parameter is small, the output torque of the AC drive may fluctuate greatly, but the response is quick.

P3.08	Vector control over-excitation gain	Default	64
	Setting Range	0~200	

During deceleration of the AC drive, over-excitation control can restrain rise of the bus voltage to avoid the overvoltage fault. The larger the over-excitation gain is, the better the restraining effect is. Increase the over-excitation gain if the AC drive is liable to overvoltage error during deceleration. Too large over-excitation gain, however, may lead to an increase in output current. Therefore,

Chapter 4 Detailed Function Description

set this parameter to a proper value in actual applications.

Set the over-excitation gain to 0 in applications of small inertia (the bus voltage will not rise during deceleration) or where there is a braking resistor.

P3.09	Torque upper limit source in speed control mode		Default	0
	Setting Range	0	P3.10	
		1	FIV	
		2	FIC	
		3	Reserved	
		4	Pulse setting	
	5	Communication setting		
P3.10	digital setting of torque upper limit in speed control mode		Default	150.0%
	Setting Range		0.0%~200.0%	

In the speed control mode, the maximum output torque of the AC drive is restricted by P3.09. If the torque upper limit is analog, pulse or communication setting, 100% of the setting corresponds to the value of P3.10, and 100% of the value of P3.10 corresponds to the AC drive rated torque.

P3.13	Excitation adjustment proportional gain	Default	2000
	Setting Range	0~20000	
P3.14	Excitation adjustment integral gain	Default	1300
	Setting Range	0~20000	
P3.15	Torque adjustment proportional gain	Default	2000
	Setting Range	0~20000	
P3.16	Torque adjustment integral gain	Default	1300
	Setting Range	0~20000	
P3.17	Speed loop integral property type	Default	0
	Setting Range	0 Invalid	
		1 Valid	

These are current loop PI parameters for vector control. These parameters are automatically obtained through "Asynchronous motor complete auto-tuning", and commonly need not be modified. The dimension of the current loop integral regulator is integral gain rather than integral time.

Note that too large current loop PI gain may lead to oscillation of the entire control loop. Therefore, when current oscillation or torque fluctuation is great, manually decrease the proportional gain or integral gain here.

P3.18-P3.22 Reserved

Group P4: V/F Control Parameters

The V/F control mode is applicable to low load applications (fan or pump) or applications where one AC drive operates multiple motors or there is a large difference between the AC drive power and the motor power.

P4.00	Settling Range	V/F curve setting	Default
		0	Linear V/F
		1	Multi-point V/F
		2	Square V/F
		3	1.2-power V/F
		4	1.4-power V/F
		6	1.6-power V/F
		8	1.8-power V/F
		9	Reserved
		10	V/F complete separation
		11	V/F half separation

0: Linear V/F

It is applicable to common constant torque load.

1: Multi-point V/F

It is applicable to special load such as dehydrator and centrifuge. Any such V/F curve can be obtained by setting parameters of P4.03 to P4.08.

2: Square V/F

It is applicable to centrifugal loads such as fan and pump.

3 to 8: V/F curve between linear V/F and square V/F

10: V/F complete separation mode

In this mode, the output frequency and output voltage of the AC drive are independent. The output frequency is determined by the frequency source, and the output voltage is determined by "Voltage source for V/F separation" (P4.13).

It is applicable to induction heating, inverse power supply and torque motor control.

11: V/F half separation mode

In this mode, V and F are proportional and the proportional relationship can be set in P4.13. The relationship between V and F is also related to the rated motor voltage and rated motor frequency in Group P2.

Assume that the voltage source input is X (0 to 100%), the relationship between V and F is: $V/F = 2 * X * (\text{Rated motor voltage}) / (\text{Rated motor frequency})$

P4.01	Torque boost	Default	Model dependent
	Setting Range	0.0%~30%	
P4.02	Cut-off frequency of torque boost	Default	50.00Hz
	Setting Range	0.00Hz~maximum output frequency	

To compensate the low frequency torque characteristics of V/F control, you can boost the output voltage of the AC drive at low frequency by modifying P4.01. If the torque boost is set to too large, the motor may overheat, and the AC drive may suffer over current. If the load is large and the motor startup torque is insufficient, increase the value of P4.01. If the load is small, decrease the value of P4.01. If it is set to 0.0, the AC drive performs automatic torque boost. In this case, the AC drive automatically calculates the torque boost value based on motor parameters including the stator resistance. P4.02 specifies the frequency under which torque boost is valid. Torque boost becomes invalid when this frequency is exceeded, as shown in the following figure.

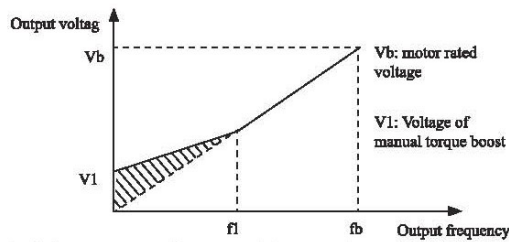

f1: Cutoff frequency of manual torque boost fb: Rated running frequency

Figure 4-5 Manual torque boost

P4.03	Multi-point V/F frequency 1 (F1)	Default	0.00Hz
	Setting Range	0.00Hz~P4.05	

Operation Instruction of NZ2000 Series Inverter

P4.04	Multi-point V/F voltage 1 (V1)	Default	0.0%
	Setting Range	0.0%~100.0%	
P4.05	Multi-point V/F frequency 2 (F2)	Default	0.00Hz
	Setting Range	P4.03~P4.07	
P4.06	Multi-point V/F voltage 2 (V2)	Default	0
	Setting Range	0.0%~100.0%	
P4.07	Multi-point V/F frequency 3 (F3)	Default	0
	Setting Range	P4.05~rated motor frequency (P2.04)	
P4.08	Multi-point V/F voltage 3 (V3)	Default	0.0%
	Setting Range	0.0%~100.0%	

These six parameters are used to define the multi-point V/F curve. The multi-point V/F curve is set based on the motor's load characteristic. The relationship between voltages and frequencies must meet: $V1 < V2 < V3$, $F1 < F2 < F3$. At low frequency, higher voltage may cause overheat or even burnt out of the motor and overcurrent stall or overcurrent protection of the AC drive.

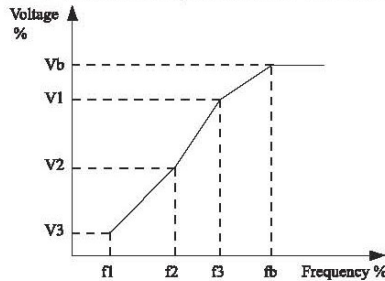

V1-V3: multi-spot V/F 1-3 stage voltage percentage

F1-F3: multi-spot V/F 1-3 stage frequency

Vb: Rated motor voltage Fb: Rated motor running frequency

Figure 4-6 Setting of multi-point V/F curve

P4.09	V/F slip compensation gain	Default	0.0%
	Setting Range	0%~200.0%	

This parameter is valid only for the asynchronous motor.

It can compensate the rotational speed slip of the asynchronous

motor when the load of the motor increases, stabilizing the motor speed in case of load changes.

If this parameter is set to 100%, it indicates that the compensation when the motor bears rated load is the rated motor slip. The rated motor slip is automatically obtained by the AC drive through calculation based on the rated motor frequency and rated motor rotational speed in group P2.

When adjust the V/F slip compensation gain, Generally, At rated load, if the motor rotational speed is different from the target speed, slightly adjust this Parameter.

P4.10	V/F over-excitation gain	Default	64
	Setting Range	0~200	

During deceleration of the AC drive, over-excitation can restrain rise of the bus voltage, to prevent the overvoltage fault. The larger the over-excitation is, the better the restraining result is.

Increase the over-excitation gain if the AC drive is liable to overvoltage error during deceleration. However, too large over-excitation gain may lead to an increase in the output current. Set P4.09 to a proper value in actual applications.

Set the over-excitation gain to 0 in the applications where the inertia is small and the bus voltage will not rise during motor deceleration or where there is a braking resistor.

P4.11	V/F oscillation suppression gain	Default	Model dependent
	Setting Range	0~100	

Set this parameter to a value as small as possible in the prerequisite of efficient oscillation suppression to avoid influence on V/F control. Set this parameter to 0 if the motor has no oscillation. Increase the value properly only when the motor has obvious oscillation. The larger the value is, the more obvious the oscillation suppression result will be.

When the oscillation suppression function is enabled, the rated motor current and no-load current must be correct. Otherwise, the V/F oscillation suppression effect will not be satisfactory.

Operation Instruction of NZ2000 Series Inverter

P4.13	Voltage source for V/F separation	Default	0
	Setting Range	0	digital setting (P4.14)
		1	FIV
		2	FIC
		3	Reserved
		4	Pulse setting(S3)
		5	Multi-reference
		6	Simple PLC
		7	PID
		8	Communication setting
100.0% corresponds to the rated motor voltage(P2.02)			
P4.14	Voltage digital setting for V/F separation	Default	0V
	Setting Range	0V~rated motor voltage	

V/F separation is generally applicable to the occasions, such as induction heating, inverse power supply and motor torque control. If V/F separated control is enabled, the output voltage can be set by function code P4.14 or by means of analog, multi-reference, simple PLC, PID or communication. If you set the output voltage by means of non-digital setting, 100% of the setting corresponds to the rated motor voltage. If a negative percentage is set, its absolute value is used as the effective value.

0: digital setting (P4.14)

The output voltage is set directly by P4.14.

1: FIV; 2:FIC

The output voltage is set by AI terminals.

3: Reserved

4: Pulse setting (S3)

The output voltage is set by pulses of the terminal S3.

Pulse setting specification: voltage range 9–30 V, frequency range 0–100 kHz

5: Multi-reference

If the voltage source is multi-reference, parameters in group P4 and PC must be set to determine the corresponding relationship between setting signal and setting voltage.

100.0% of the multi-reference setting in group FC corresponds to the rated motor voltage.

6: Simple PLC

If the voltage source is simple PLC mode, parameters in group FC

must be set to determine the setting output voltage.

7: PID

The output voltage generates based on PID closed loop. For details, see the descriptions of PID in group PA.

8: Communication setting

The output voltage is set by the host computer by the means of communication given.

The voltage source for V/F separation is set in the same way as the frequency source. 100.0% of the setting in each mode corresponds to the rated motor voltage. If the corresponding value is negative, its absolute value is used.

P4.15	Voltage rise time of V/F separation	Default	0.0s
	Setting Range	0.0s~1000.0s	
P4.16	Voltage decline time of V/F separation	Default	0.0s
	Setting Range	0.0s~1000.0s	

P4.15 indicates the time required for the output voltage to rise from 0 V to the rated motor voltage shown as t1 in the following figure.

P4.16 indicates the time required for the output voltage to decline from the rated motor voltage to 0 V, shown as t2 in the following figure.

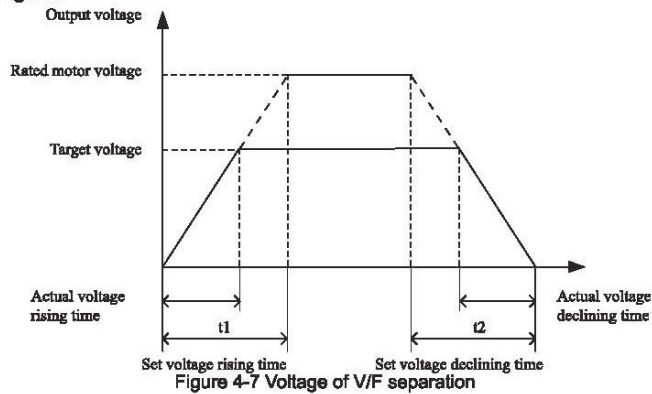

Group P5: Input Terminals

NZ2000 series inverter with 6 multi-function digital inputs (S3 can

Operation Instruction of NZ2000 Series Inverter

be used as a high-speed pulse input terminal), two analog input terminals.

P5.00	FWD function selection	Default	1 Forward RUN (FWD)
P5.01	REV function selection	Default	2 Reverse RUN (REV)
P5.02	S1 function selection	Default	9 (Fault reset)
P5.03	S2 function selection	Default	12 (Multi-reference terminal 1)
P5.04	S3 function selection	Default	13 (Multi-reference terminal 2)
P5.05	S4 function selection	Default	0

The following table lists the functions available for the multi-function input terminals.

Can choose the functions in the table as follows:

Value	Function	Description
0	No function	Set 0 for reserved terminals to avoid malfunction.
1	Forward RUN (FWD)	The terminal is used to control forward or reverse RUN of the AC drive.
2	Reverse RUN (REV)	
3	Three-line control	The terminal determines three-line control of the AC drive. For details, see the description of P5.11.
4	Forward JOG (FJOG)	FJOG indicates forward JOG running, while RJOG indicates reverse JOG running. The JOG frequency, acceleration time and deceleration time are described respectively in P8.00, P8.01 and P8.02.
5	Reverse JOG (RJOG)	
6	Terminal UP	If the frequency is determined by external terminals, the terminals with the two functions are used as increment and decrement commands for frequency modification. When the frequency source is digital setting, they are used to adjust the frequency.
7	Terminal DOWN	
8	Coast to stop	The AC drive blocks its output, the motor coasts to rest and is not controlled by the AC drive. It is the same as coast to stop described in P1.10.
9	Fault reset (RESET)	The terminal is used for fault reset function, the same as the function of RESET key on the operation panel. Remote fault reset can be implemented by this function.
10	RUN pause	The AC drive decelerates to stop, but the running parameters are all memorized, such as PLC, swing frequency and PID parameters. After this function is disabled, the AC drive resumes its status before stopping.
11	Normally open (NO) input of external fault	If this terminal becomes ON, the AC drive reports EF and performs the fault protection action. For more details, see the description of P9.47.

Chapter 4 Detailed Function Description

Value	Function	Description
12	Multi-reference terminal 1	The setting of 16 speeds or 16 other references can be implemented through combinations of 16 states of these four terminals. Refer to table 1 for more details.
13	Multi-reference terminal 2	
14	Multi-reference terminal 3	
15	Multi-reference terminal 4	
16	Terminal 1 for acceleration/ deceleration time selection	Totally four groups of acceleration/deceleration time can be selected through combinations of two states of these two terminals.
17	Terminal 2 for acceleration/ deceleration time selection	
18	Frequency source switchover	The terminal is used to switch and choose different frequency source. Choose function code P0.03 setting according to the frequency source .when set two kinds of frequency source switching as frequency source.the terminal is used to realize switching between the two frequency source.
19	UP and DOWN setting clear (terminal, operation panel)	If the frequency source is digital setting, the terminal is used to clear the modification by using the UP/ DOWN function or the increment/decrement key on the operation panel, returning the set frequency to the value of P0.10.
20	Command source switchover terminal	If the command source is set to terminal control (P0.02 = 1), this terminal is used to perform switchover between terminal control and operation panel control. If the command source is set to communication control (P0.02 = 2), this terminal is used to perform switchover between communication control and operation panel control.
21	Acceleration/ Deceleration prohibited	It enables the AC drive to maintain the current frequency output without being affected by external signals (except the STOP command).
22	PID pause	PID is invalid temporarily. The AC drive maintains the current frequency output without supporting PID adjustment of frequency source.
23	PLC status reset	The terminal is used to restore the original status of PLC control for the AC drive when PLC control is started again after a pause.

Operation Instruction of NZ2000 Series Inverter

Value	Function	Description
24	Swing pause	The AC drive outputs the central frequency, and the swing frequency function pauses.
25	Counter input	This terminal is used to count pulses.
26	Counter reset	This terminal is used to clear the counter status.
27	Length count input	This terminal is used to count the length.
28	Length reset	This terminal is used to clear the length.
29	Torque control prohibited	The AC drive is prohibited from torque control and enters the speed control mode.
30	Pulse Input (enabled only for S3)	S3 is used for pulse input.
31	Reserved	Reserved
32	Immediate DC braking	After this terminal becomes ON, the AC drive directly switches over to the DC braking state.
33	Normally closed (NC) input of external fault	After this terminal becomes ON, the AC drive reports EF and stops.
34	Frequency modification forbidden	If this terminal becomes effective, the AC drive will not respond to any frequency modification until this terminal becomes invalid.
35	Reverse PID action direction	After this terminal becomes ON, the PID action direction is reversed to the direction set in PA.03.
36	External STOP terminal 1	In operation panel mode, this terminal can be used to stop the AC drive, equivalent to the function of the STOP key on the operation panel.
37	Command source switchover terminal 2	It is used to perform switchover between terminal control and communication control. If the command source is terminal control, the system will switch over to communication control after this terminal becomes effective.
38	PID integral pause	After this terminal becomes effective, the integral adjustment function pauses. However, the proportional and differentiation adjustment functions are still valid.
39	Switchover between main frequency source X and preset frequency	After this terminal becomes effective, the frequency source X is replaced by the preset frequency set in P010.

Chapter 4 Detailed Function Description

Value	Function	Description
40	Switchover between auxiliary frequency source Y and preset frequency	After this terminal is effective, the frequency source Y is replaced by the preset frequency set in P010.
43	PID parameter switchover	If the PID parameters switchover performed by means of X terminal (PA.18 = 1), the PID parameters are PA.05 to PA.07 when the terminal becomes invalid.; the PID parameters PA.15 to PA.17 are used when this terminal becomes effective.
44	Reserved	
45	Reserved	
46	Speed control/ Torque control switchover	This terminal enables the AC drive to switch over between speed control and torque control. When this terminal becomes invalid, the AC drive runs in the mode set in C0.00. When this terminal becomes effective, the AC drive switches over to another control mode.
47	Emergency stop	When this terminal becomes effective, the AC drive stops within the shortest time. During the stop process, the current remains at the set current upper limit. This function is used to satisfy the requirement of stopping the AC drive in emergency state.
48	External STOP terminal 2	In any control mode (operation panel, terminal or communication), it can be used to make the AC drive decelerate to stop. In this case, the deceleration time is deceleration time 4.
49	Deceleration DC braking	When this terminal becomes ON, the AC drive decelerates to the initial frequency of stop DC braking and then switches over to DC braking state.
50	Clear the current running time	When this terminal becomes ON, the AC drive's current running time is cleared. This function must be supported by P8.42 and P8.53.

Additional table 1 :The descriptions of multi-reference

The four multi-reference terminals have 16 state combinations, corresponding to 16 reference values, as listed in the following table 1.

K4	K3	K2	K1	Reference Setting	CorresponXng Parameter
OFF	OFF	OFF	OFF	Reference 0	PC.00

Operation Instruction of NZ2000 Series Inverter

OFF	OFF	OFF	ON	Reference 1	PC.01
OFF	OFF	ON	OFF	Reference 2	PC.02
OFF	OFF	ON	ON	Reference 3	PC.03
OFF	ON	OFF	OFF	Reference 4	PC.04
OFF	ON	OFF	ON	Reference 5	PC.05
OFF	ON	ON	OFF	Reference 6	PC.06
OFF	ON	ON	ON	Reference 7	PC.07
ON	OFF	OFF	OFF	Reference 8	PC.08
ON	OFF	OFF	ON	Reference 9	PC.09
ON	OFF	ON	OFF	Reference 10	PC.10
ON	OFF	ON	ON	Reference 11	PC.11
ON	ON	OFF	OFF	Reference 12	PC.12
ON	ON	OFF	ON	Reference 13	PC.13
ON	ON	ON	OFF	Reference 14	PC.14
ON	ON	ON	ON	Reference 15	PC.15

If the frequency source is multi-reference, the value 100% of PC.00 to PC.15 corresponds to the maximum frequency of P012.

Besides the multi-speed function, the multi-reference can be also used as the PID setting source or the voltage source for V/ F separation, satisfying the requirement on switchover of different setting values.

Additional table 2: Terminal function descriptions of acceleration/ deceleration time selection

Terminal2	Terminal1	Acceleration/ Deceleration Time Selection	Corresponding Parameters
OFF	OFF	Acceleration/ Deceleration time 1	P0.08, P0.09
OFF	ON	Acceleration/ Deceleration time 2	P8.03, P8.04
ON	OFF	Acceleration/ Deceleration time 3	P8.05, P8.06
ON	ON	Acceleration/ Deceleration time 4	P8.07, P8.08
P5.10	X filter time		Default 0.010s
	Setting Range 0.000s~1.000s		

It is used to set the software filter time of S terminal status. If S terminals are liable to interference and may cause malfunction, increase the value of this parameter to enhance the anti-interference capability. However, increase of S filter time will reduce the response of S terminals.

Chapter 4 Detailed Function Description

P5.11	Terminal command mode	Default	0
	Setting Range	0	Two-line mode 1
		1	Two-line mode 2
		2	Three-line mode 1
3	Three-line mode 2		

This parameter defines the external terminal, control four different inverter running ways.

0:Two-line mode 1: this pattern is the most commonly used two line mode. Positive and reverse operation of the motor is determined by terminal Xx, Xy,The parameters are set as below:

Terminal	Set value	Function Description
Sx	1	Forward RUN (FWD)
Sy	2	Reverse RUN (REV)

Among them, Sx, Sy is S1 ~ S4,FWD,REV multi-function input terminals, level effectively.

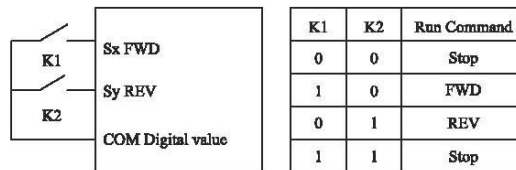

Figure 4-8 Setting of two-line mode 1

1:Two-line mode 2: use this pattern when Sx terminal functions for operation can make terminal, and Sy terminal function determined to run.

The parameters are set as below:

Terminal	Set value	Function Description
Sx	1	Forward RUN (FWD)
Sy	2	Reverse RUN (REV)

Among them, Sx, Sy is S1 ~ S4,FWD,REV multi-function input terminals, level effectively.

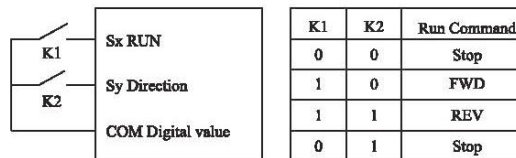

Figure 4-9 Setting of two-line mode 1

2: Three-line mode 1

In this mode, Sn is RUN enabled terminal, and the direction is respectively decided by Sx and Sy.

The parameters are set as below:

Terminal	Set value	Function Description
Sx	1	Forward RUN (FWD)
Sy	2	Reverse RUN (REV)
Sn	3	Three-line control

Sn terminal must be closed when it need to run, to realize the forward and reverse control system of the motor by Sx or Sy pulse rising.

When it need to stop, must be done by disconnecting Sn terminal signal. Among them, the Sx, Sy, Sn as S1 ~ S4,FWD,REV multi-function input terminals,Sx, Sy is the pulse effective, Sn is the level effective.

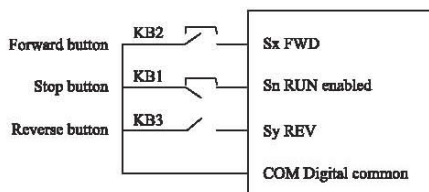

Among them,KB1: stop button KB2:forward button KB3:Reverse button

3: Three-line mode 2

In this mode, Sn is RUN enabled terminal. The RUN command is given by Sx and the direction is decided by Sy.

The parameters are set as below:

Terminal	Set value	Function Description
Sx	1	Forward RUN enabled(FWD)
Sy	2	Reverse RUN (REV)
Sn	3	Three-line control

Sn terminals must be closed when there is a need to run, Sn terminals, produced by Sx pulse rising along the motor running signal, the state of the Sy produce motor direction signals.

When there is a need to stop, by disconnecting Sn terminal signal to realize. Among them, the Sx, Sy, Sn is S1 ~ S4, FWD,REV multi-function input terminals, Sx is the pulse effective, Sy, Sn are the

level effective.

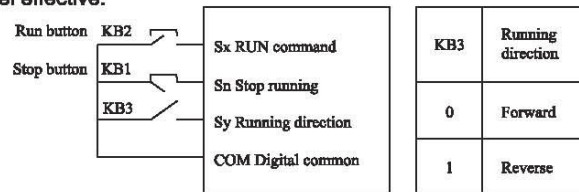

Figure 4-10-2 Setting of three-line mode 2

P5.12	Terminal UP/DOWN changing rate	Default	1.00Hz/s
	Setting Range	0.01Hz/s~65.535Hz/s	

When it is used to set terminal UP/DOWN to adjust the set frequency .Frequency changing rate is the frequency variation per second.

If P0.22 (Frequency reference resolution) is 2, the setting range is 0.001–65.535 Hz/s.

If P0.22 (Frequency reference resolution) is 1, the setting range is 0.01–655.35 Hz/s.

P5.13	FI curve 1 minimum Input	Default	0.00V
	Setting Range	0.00V~P5.15	
P5.14	Corresponding setting of FI curve 1 minimum input	Default	0.0%
	Setting Range	-100.00%~100.0%	
P5.15	FI curve 1 maximum input	Default	10V
	Setting Range	P5.13~10.00V	
P5.16	Corresponding setting of FI curve 1 maximum input	Default	100%
	Setting Range	-100.00%~100.0%	
P5.17	FI curve 1 filter time	Default	0.10s
	Setting Range	0.00s~10.00s	

These parameters are used to define the relationship between

the analog input voltage and the corresponding setting. When the analog input voltage exceeds the maximum value (P5.15), the analog voltage maximum value is calculated by "maximum input". When the analog input voltage is less than the setting minimum input (P5.13), the value set in P5.34 (Setting for FI less than minimum input) is calculated by the minimum input or 0.0%. When the analog input is current input, 20mA current corresponds to 10V voltage. 4mA current corresponds to 2V voltage. FI input filter time is used to set the software filter time of FI. If the analog input is liable to interference, increase the filter time value of this parameter to stabilize the detected analog input. However, increase of the FI curve 1 filter time will slow the response of analog detection. Set this parameter properly based on actual conditions.

In different applications, 100% of analog input corresponds to different nominal values. For details, refer to the description of different applications.

Two typical setting examples are shown in the following figure.

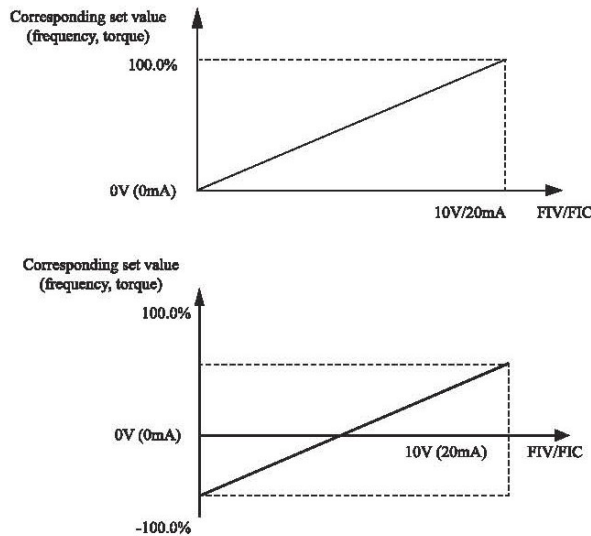

Figure 4-11 Corresponding relationship between analog input and set values

Chapter 4 Detailed Function Description

P5.18	FI curve 2 minimum input	Default	0.00V
	Setting Range	0.00V~P5.20	
P5.19	Corresponding setting of FI curve 2 minimum input	Default	0.0%
	Setting Range	-100.00%~100.0%	
P5.20	FI curve 2 maximum input	Default	10.00V
	Setting Range	P5.18~10.00V	
P5.21	Corresponding setting of FI curve 2 maximum input	Default	100.0%
	Setting Range	-100.00%~100.0%	
P5.22	FI curve 2 filter time	Default	0.10s
	Setting Range	0.00s~10.00s	
P5.23	FI curve 3 minimum input	Default	0.00V
	Setting Range	0.00V~P5.25	
P5.24	Corresponding setting of FI curve 3 minimum input	Default	0.0%
	Setting Range	-100.00%~100.0%	
P5.25	FI curve 3 maximum input	Default	10.00V
	Setting Range	P5.18~10.00V	
P5.26	Corresponding setting of FI curve 3 maximum input	Default	100.0%
	Setting Range	-100.00%~100.0%	
P5.27	FI curve 3 filter time	Default	0.10s
	Setting Range	0.00s~10.00s	

The method and functions of setting FI curve 3 are similar to that of setting FI curve 1 function.

P5.28	PULSE minimum input	Default	0.00kHz
	Setting Range	0.00kHz~P5.30	
P5.29	Corresponding setting of pulse minimum input	Default	0.0%
	Setting Range	-100.00%~100.0%	
P5.30	PULSE maximum input	Default	50.00kHz
	Setting Range	P5.28~50.00kHz	
P5.31	Corresponding setting of pulse maximum input	Default	100.0%
	Setting Range	-100.00%~100.0%	

Operation Instruction of NZ2000 Series Inverter

P5.32	PULSE filter time	Default	0.10s
	Setting Range	0.00s~10.00s	

These parameters are used to set the relationship between S3 pulse frequency input and corresponding settings. The pulses can only be input by S3. The method of setting this function is similar to that of setting FI curve 1, Refer to the descriptions of FI curve 1.

P5.33	FI curve selection	Default	321
	Setting Range	Unit's digit	FIV curve selection
		1	Curve 1 (2 points, see P5.13~P5.16)
		2	Curve 2 (2 points, see P5.18~P5.21)
		3	Curve 3 (2 points, see P5.23~P5.26)
		4	Curve 4 (4 points, see C6.00~C6.07)
		5	Curve 5 (4 points, see C6.08~C6.15)
		Ten's digit	FIC curve selection (1~5, same as FIV)
Hundred's digit	Reserved		

The unit's digit, ten's digit and hundred's digit of this parameter are respectively used to select the corresponding curve of FIV,FIC. Any one curve of the five curves can be selected for 2 analog inputs. Curve 1, curve 2 and curve 3 are all 2-point curves, need to set in group P5. Curve 4 and curve 5 are both 4-point curves, set in group C6.

The NZ2000 provides two FI terminals as standard.

P5.34	Setting for FI less than minimum input	Default	000
	Setting Range	Unit's digit	Setting for FIV less than minimum input
		0	Minimum value
		1	0.0%
		Ten's digit	Setting for FIC less than minimum input (0~1, same as FIV)
Hundred's digit	Reserved		

This function code is used to determine the corresponding setting when the analog input voltage is less than the minimum value. The unit's digit, ten's digit and hundred's digit of this function code respectively correspond to the setting for FIV,FIC and FIC. If the value of a certain digit is selected to 0, when analog input voltage is less than the minimum input, the corresponding setting of the minimum input (P5.14, P5.19, P5.24) is used.

Chapter 4 Detailed Function Description

If the value of a certain digit is selected to 1, when analog input voltage is less than the minimum input, the corresponding value of this analog input is 0.0%

P5.35	FWD delay time	Default	0.0s
	Setting Range	0.0s~3600.0s	
P5.36	REV delay time	Default	0.0s
	Setting Range	0.0s~3600.0s	
P5.37	S1 delay time	Default	0.0s
	Setting Range	0.0s~3600.0s	

These parameters are used to set the delay time of the AC drive when the status of the terminal changes.

Currently, only FWD, REV and S1 support the delay time function.

P5.38	S valid mode selection 1	Default	00000
	Setting Range	Unit's digit	FWD valid mode
		0	High level valid
		1	Low level valid
		Ten's digit	REV valid mode (0~1, same as FWD)
		Hundred's digit	S1 valid mode (0~1, same as FWD)
		Thousand's digit	S2 valid mode (0~1, same as FWD)
Ten thousand's digit	S3 valid mode (0~1, same as FWD)		
P5.39	S valid mode selection 2	Default	00000
	Setting Range	Unit's digit	S4 valid mode
		0	High level valid
		1	Low level valid

These parameters are used to set digital input terminals' valid mode. The S terminal is valid when being connected with GND, and invalid when being disconnected from GND.

The S terminal is invalid when being connected with GND, and valid when being disconnected from GND.

Group P6: Output Terminals

The NZ2000 provides 1 multi-function analog output terminal FOV, 1 multi-function relay output terminal and a M01 terminal (used for high-speed pulse output or open-collector switch signal output) as

standard.

P6.00	M01 terminal output mode	Default	1
	Setting Range	1	Switch signal output
P6.01	M01 function (open-collector output terminal)	Default	0
P6.02	Relay output function (RA-RB-RC)	Default	2

These two parameters are used to select the functions of the five digital output terminals. RA-RB-RC are respectively the relays on the control board and the extension card. The functions of the output terminals are described in the following table.

Table 4-5 Functions of output terminals

Value	Function	Description
0	No output	The terminal has no function.
1	AC drive running	When the AC drive is running and has output frequency (can be zero), the terminal outputs ON.
2	Fault output (stop)	When the AC drive stops due to a fault, the terminal outputs ON.
3	Frequency-level detection FDT1 output	Refer to the descriptions of P8.19 and P8.20.
4	Frequency reached	Refer to the descriptions of P8.21.
5	Zero-speed running (no output at stop)	If the AC drive runs with the output frequency of 0, the terminal outputs ON. If the AC drive is in the stop state, the terminal outputs OFF.
6	Motor overload pre-warning	The AC drive judges whether the motor load exceeds the overload pre-warning threshold before performing the protection action. If the pre-warning threshold is exceeded, the terminal outputs ON. For motor overload parameters, see the descriptions of P9.00 to P9.02.
7	AC drive overload pre-warning	The terminal outputs ON 10s before the AC drive overload protection action is performed.
8	Set count value reached	The terminal outputs ON when the count value reaches the value set in Pb.08.
9	Designated count value reached	The terminal outputs ON when the count value reaches the value set in Pb.09.
10	Length reached	The terminal outputs ON when the detected actual length exceeds the value set in Pb.05.
11	PLC cycle complete	When simple PLC completes one cycle, the terminal outputs a pulse signal with width of 250 ms.

Chapter 4 Detailed Function Description

Value	Function	Description
12	Accumulative running time reached	If the accumulative running time of the AC drive exceeds the time set in P8.17, the terminal outputs ON.
13	Frequency limited	If the set frequency exceeds the frequency upper limit or lower limit and the output frequency of the AC drive reaches the upper limit or lower limit, the terminal outputs ON.
14	Torque limited	In speed control mode, if the output torque reaches the torque limit, the AC drive enters the stall protection state and meanwhile the terminal outputs ON.
15	Ready for RUN	If the AC drive main circuit and control circuit become stable, and the AC drive detects no fault and is ready for RUN, the terminal outputs ON.
16	FIV>FIC	When the input of FIV is larger than the input of FIC, the terminal outputs ON.
17	Frequency upper limit reached	If the running frequency reaches the upper limit, the terminal outputs ON.
18	Frequency lower limit reached (no output at stop)	If the running frequency reaches the lower limit, the terminal becomes ON. In the stop state, the terminal outputs OFF.
19	Under voltage state output	If the AC drive is in under voltage state, the terminal outputs ON.
20	Communication setting	Refer to the communication protocol.
21	Reserved	Reserved
22	Reserved	Reserved
23	Zero-speed running 2 (having output at stop)	If the output frequency of the AC drive is 0, the terminal becomes ON. In the state of stop, the signal is still ON.
24	Accumulative power-on time reached	If the AC drive accumulative power-on time (P7.13) exceeds the value set in P8.16, the terminal becomes ON.
25	Frequency level detection FDT2 output	Refer to the descriptions of P8.28 and P8.29.
26	Frequency 1 reached output	Refer to the descriptions of P8.30 and P8.31.
27	Frequency 2 reached output	Refer to the descriptions of P8.32 and P8.33.

Operation Instruction of NZ2000 Series Inverter

Value	Function	Description
28	Current 1 reached output	Refer to the descriptions of P8.38 and P8.39.
29	Current 2 reached output	Refer to the descriptions of P8.40 and P8.41.
30	Timing reached output	If the timing function (P8.42) is valid, the terminal becomes ON after the current running time of the AC drive reaches the set time.
31	FIV input limit exceeded	If FIV input is larger than the value of P9.46 (FIV input voltage upper limit) or lower than the value of P9.45 (FIV input voltage lower limit), the terminal outputs ON.
32	Load becoming 0	If the load becomes 0, the terminal outputs ON.
33	Reverse running	If the AC drive is in the reverse running state, the terminal outputs ON.
34	Zero current state	Refer to the descriptions of P8.28 and P8.29.
35	Module temperature reached	If the heatsink temperature of the inverter module (P7.07) reaches the set module temperature threshold (P8.47), the terminal outputs ON.
36	Software current limit exceeded	Refer to the descriptions of P8.36 and P8.37.
37	Frequency lower limit reached (having output at stop)	If the running frequency reaches the lower limit, the terminal becomes ON. In the stop state, the signal is still ON.
38	Alarm output	If a fault occurs on the AC drive and the AC drive continues to run, the terminal outputs the alarm signal.
39	Reserved	Reserved
40	Current running time reached	If the current running time of AC drive exceeds the value of P8.53, the terminal outputs ON.
P6.07	FOV output function selection	Default 0
P6.08	Reserved	

The output range of FOV is 0–10 V or 0–20 mA. The relationship between pulse and analog output ranges and corresponding functions is listed in the following table.

Table 4-6 Relationship between pulse and analog output ranges and corresponding functions.

Chapter 4 Detailed Function Description

Value	Function	Range (Corresponding to Pulse or Analog Output Range 0.0%~100.0%)
0	Running frequency	0~maximum output frequency
1	Set frequency	0~maximum output frequency
2	Output current	0~2 times of rated motor current
3	Output torque	0~2 times of rated motor torque
4	Output power	0~2 times of rated power
5	Output voltage	0~1.2 times of rated AC drive voltage
6	Pulse Input	0.01kHz~100.00kHz
7	FIV	0V~10V
8	FIC	0V~10V (or 0~20mA)
9	Reserved	
10	Length	0~maximum set length
11	Count value	0~maximum count value
12	Communication setting	0.0%~100.0%
13	Motor rotational speed	0~rotational speed corresponding to maximum output frequency
14	Output current	0.0A~1000.0A
15	Output voltage	0.0V~1000.0V
P6.10	FOV zero offset coefficient	Default 0.0%
	Setting Range	-100.0%~+100.0%
P6.11	FOV gain	Default 1.00
	Setting Range	-10.00~+10.00
P6.12	Reserved	
P6.13	Reserved	

These function codes are used to correct the zero drift of analog output and the output amplitude deviation. They can also be used to define the desired FOV curve.

If "b" represents zero offset, "k" represents gain, "Y" represents actual output, and "X" represents standard output, the actual output is: $Y = kX + b$.

Among them the zero offset coefficient 100% of FOV corresponds to 10V (or 20 mA). The standard output refers to the value corresponding to the analog output of 0 to 10V (or 0 to 20 mA) with no zero offset or gain adjustment.

For example, if the analog output is used as the running frequency, and it is expected that the output is 8V when the frequency at the maximum frequency is 3V, the gain shall be set to -0.50, and the zero offset shall be set to 80%.

Operation Instruction of NZ2000 Series Inverter

P6.17	M01 output delay time	Default	0.0s
	Setting Range	0.0s~3600.0s	
P6.18	RA-RB-RC output delay time	Default	0.0s
	Setting Range	0.0s~3600.0s	

These parameters are used to set the delay time of output terminals M01, relay 1 from status change to actual output.

P6.22	Output terminal valid mode selection	Default	00000
	Setting Range	Unit's digit	M01 valid model
		0	Positive logic
		1	Negative logic
Ten's digit	RA-RB-RC valid mode (0~1, the same as M01)		

It is used to definite the logic of output terminals M01,RA,RB,RC.

0: Positive logic

The output terminal is valid when it is connected with GND, and invalid when it is disconnected from GND.

1: Negative logic

The output terminal is invalid when it is connected with GND, and valid when it is disconnected from GND.

Group P7: Operation Panel and Display

P7.00	Output power correction factor	Default	100.0
	Setting Range	0	0.0~200.0

Can correct output power by modifying parameter P7.00, (output power can be viewed through the parameter D0.05)

P7.01 Reserved

P7.02	STOP/RESET key function	Default	1
	Setting Range	0	STOP/RESET key enabled only in operation panel control
		1	STOP/RESET key enabled in any operation mode

P7.03	LED display running parameters 1	Default	1F
	Setting Range	0000 ~FFFF	<p> 7 6 5 4 3 2 1 0 Running frequency 1 (Hz) Set frequency (Hz) Bus voltage (V) Output voltage (V) Output current (A) Output power (kW) Output torque (%) S input status (V) </p> <p> 15 14 13 12 11 10 9 8 YO output status FIV voltage (V) FIC current (mA) Reserved Count value Length value Load speed display PID setting </p> <p> If a parameter needs to be displayed during the running, set the corresponding bit to 1, and set P7.03 to the hexadecimal equivalent of this binary number. </p>

Operation Instruction of NZ2000 Series Inverter

	LED display running parameters 2	Default	0
P7.04	Setting Range 0000 ~FFFF	7 6 5 4 3 2 1 0	<ul style="list-style-type: none"> — PID feedback — PLC stage — PULSE setting frequency (KHz) — Running frequency 2 — Remaining running time — FIV vottage before correction — FIC current before correction — Reserved
		15 14 13 12 11 10 9 8	<ul style="list-style-type: none"> — Linear speed — current power-on time (Hour) — current running time (Minute) — PULSE setting frequency (Hz) — Communication setting value — Reserved — Main frequency X display (Hz) — Auxliary frequency Y display (Hz)
<p>If a parameter needs to be displayed during the running, set the corresponding bit to 1, and set P7.04 to the hexadecimal equivalent of this binary number.</p>			

Run the display parameters, used to set the parameters that can be viewed when the AC drive is in any running state.

Chapter 4 Detailed Function Description

P7.05	LED display stop parameters	Default	33
	Setting Range	0000 ~FFFF	<p>If a parameter needs to be displayed during the running, set the corresponding bit to 1, and set P7.05 to the hexadecimal equivalent of this binary number.</p>
P7.06	Load speed display coefficient	Default	1.0000
	Setting Range	0.0001~6.5000	
P7.07	Heatsink temperature of inverter	Default	Read-only
	Setting Range	0.0°C~150.0°C	

This parameter is used to adjust the relationship between the output frequency of the AC drive and the load speed. For details, see the description of P7.12.

It is used to display the insulated gate bipolar transistor (IGBT) temperature of the inverter module, and the IGBT overheat

protection value of the inverter module depends on the model.

P7.08	Temporary software version	Default	Read-only
	Setting Range	0.0°C~150.0°C	

It is used to display the temporary software version of the control board.

P7.09	Accumulative running time	Default	0h
	Setting Range	0h~65535h	

It is used to display the accumulative running time of the AC drive. After the accumulative running time reaches the value set in P8.17, the terminal with the digital output function 12 outputs ON.

P7.10	reserved	Default	
P7.11	Software version	Default	
	Setting Range	Software version of control board	
P7.12	Number of decimal places for load speed display	Default	0
	Setting Range	0	0 decimal place
		1	1 decimal place
		2	2 decimal places
		3	3 decimal places

P7.12 is used to set the number of decimal places for load speed display. The following gives an example to explain how to calculate the load speed:

Assume that P7.06 (Load speed display coefficient) is 2.000 and P7.12 is 2 (2 decimal places). When the running frequency of the AC drive is 40.00 Hz, the load speed is $40.00 \times 2.000 = 80.00$ (display of 2 decimal places).

If the AC drive is in the stop state, the load speed is the speed corresponding to the set frequency, namely, "set load speed". If the set frequency is 50.00 Hz, the load speed in the stop state is $50.00 \times 2.000 = 100.00$ (display of 2 decimal places).

P7.13	Accumulative power-on time	Default	0h
	Setting Range	0h~65535h	

It is used to display the accumulative power-on time of the AC drive since the delivery. If the time reaches the set power-on time (P8.17), the terminal with the digital output function 24 outputs ON.

P7.14	Accumulative power consumption	Default	-
	Setting Range	0~65535kWh	

It is used to display the accumulative power consumption of the AC

drive until now.

Group P8: Auxiliary Functions

P8.00	JOG running frequency	Default	2.00Hz
	Setting Range	0.00Hz~maximum frequency	
P8.01	JOG acceleration time	Default	20.0s
	Setting Range	0.0s~6500.0s	
P8.02	JOG deceleration time	Default	20.0s
	Setting Range	0.0s~6500.0s	

These parameters are used to define the set frequency and acceleration/deceleration time of the AC drive when jogging. The startup mode is "Direct start" (P1.00 = 0) and the stop mode is "Decelerate to stop" (P1.10 = 0) during jogging.

P8.03	Acceleration time 2	Default	Model dependent
	Setting Range	0.0s~6500.0s	
P8.04	Deceleration time 2	Default	Model dependent
	Setting Range	0.0s~6500.0s	
P8.05	Acceleration time 3	Default	Model dependent
	Setting Range	0.0s~6500.0s	
P8.06	Deceleration time 3	Default	Model dependent
	Setting Range	0.0s~6500.0s	
P8.07	Acceleration time 4	Default	Model dependent
	Setting Range	0.0s~6500.0s	
P8.08	Deceleration time 4	Default	Model dependent
	Setting Range	0.0s~6500.0s	

The NZ2000 provides a total of four groups of acceleration/ deceleration time, that is, the preceding three groups and the group defined by P0.08 and P0.09. Definitions of four groups are completely the same. You can switch over between the four groups of acceleration/deceleration time through different state combinations of S terminals. For more details, see the descriptions of P5.01 to P5.05.

P8.09	Jump frequency 1	Default	0.00Hz
	Setting Range	0.00Hz~maximum frequency	
P8.10	Jump frequency 2	Default	0.00Hz
	Setting Range	0.00 Hz~maximum frequency	
P8.11	Frequency jump amplitude	Default	0.00Hz
	Setting Range	0.00~maximum frequency	

If the set frequency is within the frequency jump range, the actual

running frequency is the jump frequency close to the set frequency. Setting the jump frequency helps to avoid the mechanical resonance point of the load.

The NZ2000 supports two jump frequencies. If both are set to 0, the frequency jump function is disabled. The principle of the jump frequencies and jump amplitude is shown in the following figure.

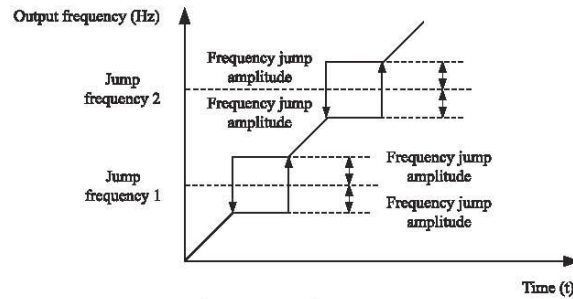

Figure 4-12 Principle of the jump frequencies and jump amplitude

P8.12	Forward/Reverse rotation dead-zone time	Default	0.0s
	Setting Range	0.00s~3000.0s	

It is used to set the time when the output is 0 Hz at transition of the AC drive forward rotation and reverse rotation, as shown in the following figure.

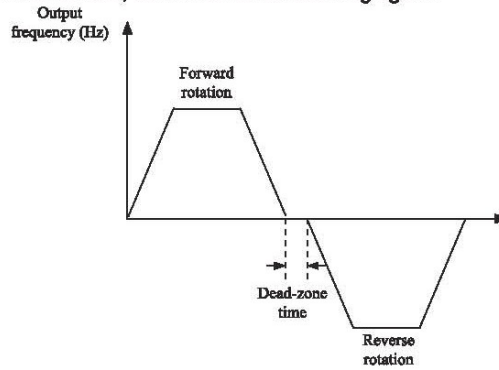

Figure 4-13 Forward/Reverse rotation dead-zone time

Chapter 4 Detailed Function Description

P8.13	Reverse control	Default	0
	Setting Range	0	permitted
		1	prohibited

It is used to set whether the AC drive allows reverse rotation. In the applications where reverse rotation is prohibited, set this parameter to 1.

P8.14	Running mode when set frequency lower than frequency lower limit	Default	0
	Setting Range	0	Run at frequency lower limit
		1	Stop
	2	Run at zero speed	

It is used to set the AC drive running mode when the set frequency is lower than the frequency lower limit. The NZ2000 provides three running modes to satisfy requirements of various applications.

P8.15	Droop control	Default	0.00Hz
	Setting Range	0.00Hz~10.00Hz	

This function is used for balancing the workload allocation when multiple motors are used to drive the same load. The output frequency of the AC drives decreases as the load increases. You can reduce the workload of the motor under load by decreasing the output frequency for this motor, implementing workload balancing between multiple motors.

P8.16	Accumulative power-on time threshold	Default	0h
	Setting Range	0h~65000h	

If the accumulative power-on time (P7.13) reaches the value set in P8.16 parameter, the corresponding M01 terminal outputs ON(P6.01=24).

P8.17	Accumulative running time threshold	Default	0h
	Setting Range	0h~65000h	

It is used to set the accumulative running time threshold of the AC drive. If the accumulative running time (P7.09) reaches the value set in this parameter, the corresponding M01 terminal outputs ON(P6.01=40).

P8.18	Startup protection	Default	0
	Setting Range	0	No
		1	Yes

This parameter is used to set whether to enable the safety

protection. If it is set to 1, the AC drive does not respond to the running command valid upon AC drive power-on (for example, an input terminal is ON before power-on). The AC drive responds only after the running command is cancelled and becomes valid again. In addition, the AC drive does not respond to the running command valid upon fault reset of the AC drive. The run protection can be disabled only after the running command is cancelled. In this way, this parameter is set to 1, the motor can be protected from responding to run commands upon power-on or fault reset in unexpected conditions.

P8.19	Frequency detection value (FDT1)	Default	50.00Hz
	Setting Range	0.00Hz~maximum frequency	
P8.20	Frequency detection hysteresis (FDT1)	Default	5.0%
	Setting Range	0.0%~100.0% (FDT1 level)	

If the running frequency is higher than the value of frequency detection the corresponding M01 terminal becomes ON. If the running frequency is lower than value of P8.19, that the M01 terminal outputs on is cancelled.

These two parameters are respectively used to set the detection value of output frequency and hysteresis value upon cancellation of the output. The value of P8.20 is a percentage of the hysteresis frequency to the frequency detection value (P8.19).The FDT function is shown in the following figure.

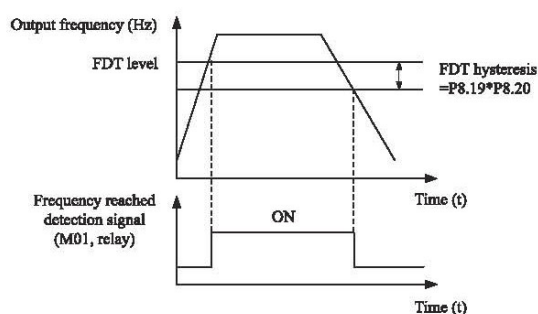

Figure 4-14 FDT level

P8.21	Detection range of frequency reached	Default	0.0%
	Setting Range	0.00~100% (maximum frequency)	

If the AC drive's running frequency is within the certain range of the set frequency, the corresponding M01 terminal becomes ON. This parameter is used to set the range within which the output frequency is detected to reach the set frequency. The value of this parameter is a percentage relative to the maximum frequency. The detection range of frequency reached is shown in the following figure.

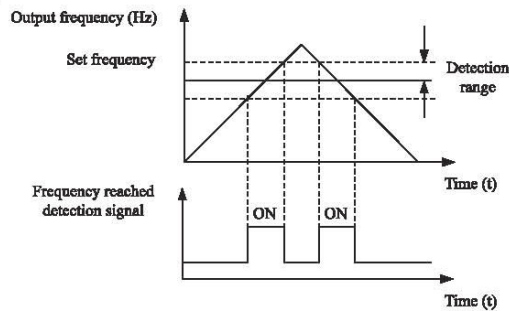

Figure 4-15 Detection range of frequency reached

P8.22	Jump frequency during the process of acceleration/deceleration	Default	1
	Setting Range	0: Disabled 1: Enabled	

It is used to set whether the jump frequency is valid during the process of acceleration/deceleration. When the jump frequency is valid during acceleration/deceleration, and the running frequency is within the frequency jump range, the actual running frequency will jump over the set frequency jump amplitude (rise directly from the lowest jump frequency to the highest jump frequency). The following figure shows the diagram when the jump frequency is valid during acceleration/deceleration.

Operation Instruction of NZ2000 Series Inverter

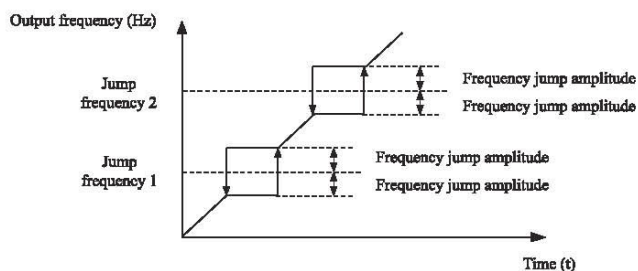

Figure 4-16 Diagram when the jump frequency is valid during the process of acceleration/deceleration

P8.25	Frequency switchover point between acceleration time 1 and acceleration time 2	Default	0.00Hz
	Setting Range	0.00Hz~maximum frequency	
P8.26	Frequency switchover point between deceleration time 1 and deceleration time 2	Default	0.00Hz
	Setting Range	0.00Hz~maximum frequency	

This function is valid when the motor selects acceleration/deceleration time that is not performed by means of S terminal's switchover. It is used to select different groups of acceleration/deceleration time based on the running frequency range rather than S terminal during the running process of the AC drive.

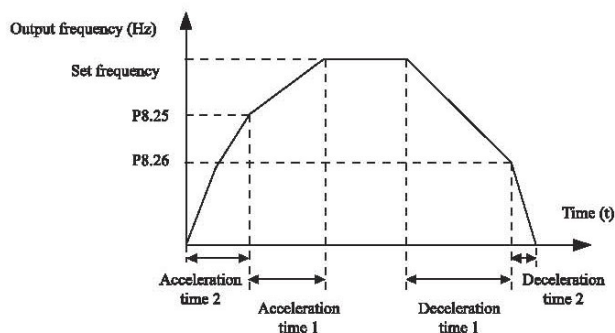

Figure 4-17 Acceleration/deceleration time switchover

Chapter 4 Detailed Function Description

During the process of acceleration, if the running frequency is smaller than the value of P8.25, acceleration time 2 is selected. If the running frequency is larger than the value of P8.25, acceleration time 1 is selected.

During the process of deceleration, if the running frequency is larger than the value of P8.26, deceleration time 1 is selected. If the running frequency is smaller than the value of P8.26, deceleration time 2 is selected.

P8.27	Terminal JOG preferred	Default	0
	Setting Range	0: Disabled 1: Enabled	

It is used to set whether terminal JOG is the highest priority.

If terminal JOG is preferred, the AC drive switches to terminal JOG running state when there is a terminal JOG command during the running process of the AC drive.

P8.28	Frequency detection value (FDT2)	Default	50.00Hz
	Setting Range	0.00Hz~maximum frequency	
P8.29	Frequency detection hysteresis (FDT2)	Default	5.0%
	Setting Range	0.0%~100.0% (FDT2 level)	

The frequency detection function is the same as FDT1 function. For details, refer to the descriptions of P8.19 and P8.20.

P8.30	Any frequency reaching detection value 1	Default	50.00Hz
	Setting Range	0.00 Hz~ maximum frequency	
P8.31	Any frequency reaching detection amplitude 1	Default	0.0%
	Setting Range	0.0%~100.0% (maximum frequency)	
P8.32	Any frequency reaching detection value 2	Default	50.00Hz
	Setting Range	0.00Hz~maximum frequency	
P8.33	Any frequency reaching detection amplitude 2	Default	0.0%
	Setting Range	0.0%~100.0% (maximum frequency)	

If the output frequency of the AC drive is within the positive and negative amplitudes of the any frequency reaching detection value, the corresponding M01 outputs ON(P6.01=26/27).

The NZ2000 provides two groups of any frequency reaching detection parameters, including frequency detection value and

detection amplitude, as shown in the following figure.

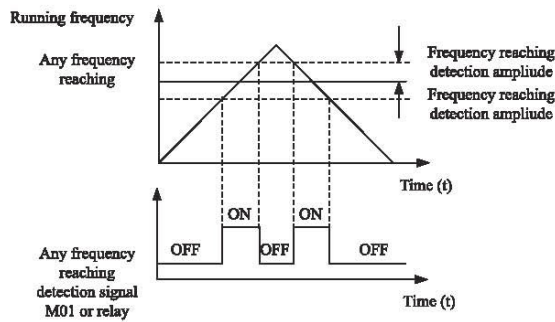

Figure 4-18 Any frequency reaching detection

P8.34	Zero current detection level	Default	5.0%
	Setting Range	0.0%~300.0% (rated motor current)	
P8.35	Zero current detection delay time	Default	0.10s
	Setting Range	0.01s~600.00s	

If the output current of the AC drive is equal to or less than the zero current detection level and the duration exceeds the zero current detection delay time, the corresponding M01 becomes ON. The zero current detection is shown in the following figure.

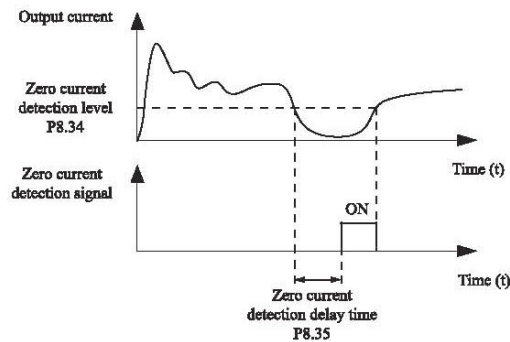

Figure 4-19 Zero current detection

Chapter 4 Detailed Function Description

P8.36	Output over current threshold	Default	200.0%
	Setting Range	0.0% (no detection) 0.1%~300.0% (rated motor current)	
P8.37	Output over current detection delay time	Default	0.00s
	Setting Range	0.00s~600.00s	

If the output current of the AC drive is equal to or higher than the over current threshold and the duration exceeds the detection delay time, the corresponding M01 becomes ON. The output over current detection function is shown in the following figure.

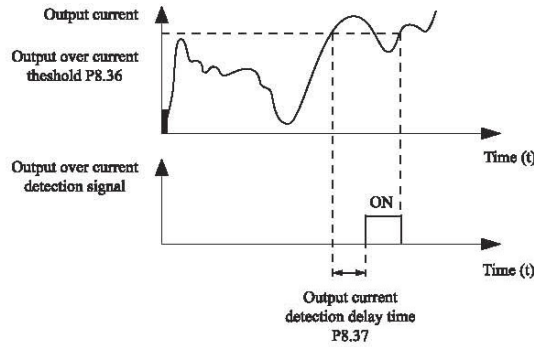

Figure 4-20 Output over current detection

P8.38	Any current reaching 1	Default	100.0%
	Setting Range	0.0%~300.0% (rated motor current)	
P8.39	Any current reaching 1 amplitude	Default	0.0%
	Setting Range	0.0%~300.0% (rated motor current)	
P8.40	Any current reaching 2	Default	100.0%
	Setting Range	0.0%~300.0% (rated motor current)	
P8.41	Any current reaching 2 amplitude	Default	0.0%
	Setting Range	0.0%~300.0% (rated motor current)	

If the output current of the AC drive is within the positive and negative amplitudes of any current reaching detection value, the corresponding M01 becomes ON.

The NZ2000 provides two groups of any current reaching detection

parameters, including current detection value and detection amplitudes, as shown in the following figure.

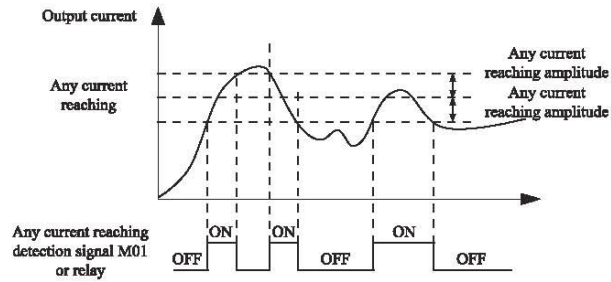

Figure 4-21 Any current reaching detection

P8.42	Timing function selection	Default	0
	Setting Range	0	Disabled
		1	Enabled
P8.43	Timing duration selection	Default	0
	Setting Range	0	P8.44
		1	FIV
		2	FIC
		3	Reserved
	100% of analog input corresponds to the value of P8.44		
P8.44	Timing duration	Default	0.0Min
	Setting Range	0.0Min~6500.0Min	

These parameters are used to implement the AC drive timing function.

If P8.42 is set to 1, the AC drive starts to time at startup. When the set timing duration is reached, the AC drive stops automatically and meanwhile the corresponding M01 outputs ON.

The AC drive starts timing from 0 each time it starts up and the remaining timing duration can be queried by D0.20. The timing duration is set in P8.43 and P8.44, in the unit of minute.

P8.45	FIV input voltage lower limit	Default	3.10V
	Setting Range	0.00V~P8.46	
P8.46	FIV input voltage upper limit	Default	6.80V
	Setting Range	P8.45~10.00V	

Chapter 4 Detailed Function Description

These two parameters are used to set the limits of the input voltage to provide protection on the AC drive. When the FIV input is larger than the value of P8.46 or smaller than the value of P8.45, the corresponding M01 becomes ON, indicating that whether FIV input exceeds the limit.

P8.47	Module temperature	Default	100°C
	Setting Range	0~150°C	

When the heat sink temperature of the AC drive reaches the value of this parameter, the corresponding M01 becomes ON, indicating that the module temperature reaches the threshold.

P8.48	Cooling fan control	Default	0
	Setting Range	0: Fan working during running 1: Fan working continuously	

It is used to set the working mode of the cooling fan. If this parameter is set to 0, the fan works when the AC drive is in running state. When the AC drive stops, the cooling fan works if the heat sink temperature is higher than 40°C, and stops working if the heat sink temperature is lower than 40°C.

If this parameter is set to 1, the cooling fan keeps working after power-on.

P8.49	Wakeup frequency	Default	0.00Hz
	Setting Range	Dormant frequency (P8.51) ~maximum frequency (P0.12)	
P8.50	Wakeup delay time	Default	0.0s
	Setting Range	0.0s~6500.0s	
P8.51	Dormant frequency	Default	0.00Hz
	Setting Range	0.00Hz~wakeup frequency (P8.49)	
P8.52	Dormant delay time	Default	0.0s
	Setting Range	0.0s~6500.0s	

These parameters are used to implement the dormant and wakeup functions in the water supply application.

When the AC drive is in running state, the AC drive enters the dormant state and stops automatically after the dormant delay time (P8.52) if the set frequency is lower than or equal to the dormant frequency (P8.51).

When the AC drive is in dormant state and the current running command is effective, the AC drives starts up after the wakeup delay time (P8.50) if the set frequency is higher than or equal to the wakeup frequency (P8.49).

Generally, set the wakeup frequency equal to or higher than the dormant frequency. If the wakeup frequency and dormant frequency are set to 0, the dormant and wakeup functions are disabled.

When the dormant function is enabled, if the frequency source is PID, whether PID operation is performed in the dormant state is determined by PA.28. In this case, select PID operation enabled in the stop state (PA.28 = 1).

P8.53	Current running time reached	Default	0.0Min
	Setting Range	0.0Min~6500.0Min	

If the current running time reaches the value set in this parameter, the corresponding M01 becomes ON, indicating that the current running time is reached.

Group P9: Fault and Protection

P9.00	Motor overload protection selection	Default	1
	Setting Range	0 1	Disabled Enabled
P9.01	Motor overload protection gain	Default	1.00
	Setting Range	0.20~10.00	

P9.00 = 0

The motor overload protective function is disabled. The motor is exposed to potential damage due to overheating. A thermal relay is suggested to be installed between the AC drive and the motor.

P9.00 = 1

The AC drive judges whether the motor is overloaded according to the inverse time-lag curve of the motor overload protection.

The inverse time-lag curve of the motor overload protection is:

220% *P9.01 *rated motor current (if the load remains at this value for one minute, the AC drive reports motor overload fault), or 150% *P9.01 * rated motor current (if the load remains at this value for 60 minutes, the AC drive reports motor overload fault).

Set P9.01 properly based on the actual overload capacity. If the value of P9.01 is set too large, the damage to the motor may result when the motor overheats but the AC drive does not report the alarm.

Chapter 4 Detailed Function Description

P9.02	Motor overload warning coefficient	Default	80%
	Setting Range	50%~100%	

This function is used to give a warning signal to the control system via M01 before motor overload protection. This parameter is used to determine the percentage, at which pre-warning is performed before motor overload. The larger the value is, the less advanced the pre-warning will be.

When the accumulative output current of the AC drive is greater than the value of the overload inverse time-lag curve multiplied by P9.02, the multifunction digital M01 terminal on the AC drive (Motor overload pre-warning) becomes ON.

P9.03	Overvoltage stall gain	Default	10
	Setting Range	0 (no stall overvoltage) ~100	
P9.04	Overvoltage stall protective voltage	Default	130%
	Setting Range	120%~150% (Three phase)	

When the DC bus voltage exceeds the value of P9.04 (Overvoltage stall protective voltage) during deceleration of the AC drive, the AC drive stops deceleration and keeps the present running frequency. After the bus voltage declines, the AC drive continues to decelerate. P9.03 (Overvoltage stall gain) is used to adjust the overvoltage suppression capacity of the AC drive. The larger the value is, the greater the overvoltage suppression capacity will be.

In the prerequisite of no overvoltage occurrence, set P9.03 to a small value.

For small-inertia load, the value should be small. Otherwise, the system dynamic response will be slow. For large-inertia load, the value should be large. Otherwise, the suppression result will be poor and an overvoltage fault may occur. If the overvoltage stall gain is set to 0, the overvoltage stall function is disabled.

P9.05	Over current stall gain	Default	20
	Setting Range	0~100	
P9.06	Over current stall protective current	Default	150%
	Setting Range	100%~200%	

When the output current exceeds the over current stall protective current during acceleration/deceleration of the AC drive, the AC

drive stops acceleration/deceleration and keeps the present running frequency. After the output current declines, the AC drive continues to accelerate/decelerate.

P9.05 (Over current stall gain) is used to adjust the over current suppression capacity of the AC drive. The larger the value is, the greater the over current suppression capacity will be. In the prerequisite of no over current occurrence, set P9.05 to a small value.

For small-inertia load, the value should be small. Otherwise, the system dynamic response will be slow. For large-inertia load, the value should be large. Otherwise, the suppression result will be poor and over current fault may occur. If the over current stall gain is set to 0, the over current stall function is disabled.

P9.07	Short-circuit to ground upon power-on	Default	1
	Setting Range	0	Disabled
		1	Enabled

It is used to determine whether to check the motor is short-circuited to ground at power-on of the AC drive. If this function is enabled, the AC drive's UVW will have voltage output a while after power-on.

P9.09	Fault auto reset times	Default	0
	Setting Range	0~20	

It is used to set the times of fault auto resets if this function is used. After the value is exceeded, the AC drive will remain in the fault state.

P9.10	M01 action during fault auto reset	Default	1
	Setting Range	0:Not action 1:Action	

It is used to decide whether the M01 acts during the fault auto reset if the fault auto reset function is selected.

P9.11	Time interval of fault auto reset	Default	1.0s
	Setting Range	0.1s~100.0s	

It is used to set the waiting time from the alarm of the AC drive to fault auto reset.

P9.12 Reserved

Chapter 4 Detailed Function Description

P9.13	Output phase loss protection selection	Default	1
	Setting Range	0:Prohibited 1:Permitted	

It is used to determine whether to perform output phase loss protection.

P9.14	1st fault type	0-99
P9.15	2nd fault type	
P9.16	3rd (latest) fault type	

It is used to record the types of the most recent three faults of the AC drive. 0 indicates no fault. For possible causes and solution of each fault, refer to Chapter 5.

P9.17	Frequency upon 3rd fault	It displays the frequency when the latest fault occurs.																				
P9.18	Current upon 3rd fault	It displays the current when the latest fault occurs.																				
P9.19	Bus voltage upon 3rd fault	It displays the bus voltage when the latest fault occurs.																				
P9.20	Input terminal status upon 3rd fault	It displays the status of all input terminals when the latest fault occurs. The sequence is as follows: <table border="1" style="margin-left: 20px;"> <tr> <td>BIT9</td><td>BIT8</td><td>BIT7</td><td>BIT6</td><td>BIT5</td><td>BIT4</td><td>BIT3</td><td>BIT2</td><td>BIT1</td><td>BIT0</td> </tr> <tr> <td></td><td></td><td></td><td></td><td>S4</td><td>S3</td><td>S2</td><td>S1</td><td>REV</td><td>FWD</td> </tr> </table>	BIT9	BIT8	BIT7	BIT6	BIT5	BIT4	BIT3	BIT2	BIT1	BIT0					S4	S3	S2	S1	REV	FWD
		BIT9	BIT8	BIT7	BIT6	BIT5	BIT4	BIT3	BIT2	BIT1	BIT0											
				S4	S3	S2	S1	REV	FWD													
		If an input terminal is ON, the setting is 1, the OFF is 0, the setting is 0. The value is the equivalent decimal number converted from the S status.																				
P9.21	Output terminal status upon 3rd fault	It displays the status of all output terminals when the latest fault occurs. The sequence is as follows: <table border="1" style="margin-left: 20px;"> <tr> <td>BIT3</td><td>BIT2</td><td>BIT1</td><td>BIT0</td> </tr> <tr> <td></td><td></td><td>RA, RB, RC</td><td>YO</td> </tr> </table>	BIT3	BIT2	BIT1	BIT0			RA, RB, RC	YO												
		BIT3	BIT2	BIT1	BIT0																	
		RA, RB, RC	YO																			
		If an output terminal is ON, the setting is 1, the OFF is 0. If the output terminal is OFF, the setting is 0. The value is the equivalent decimal number converted from the S statuses.																				
P9.22	AC drive status upon 3rd fault	Reserved																				
P9.23	Power-on time upon 3rd fault	It displays the present power-on time when the latest fault occurs.																				

Operation Instruction of NZ2000 Series Inverter

P9.24	Running time upon 3rd fault	It displays the present running time when the latest fault occurs.	
P9.27	Frequency upon 2nd fault	Same as P9.17~P9.24	
P9.28	Current upon 2nd fault		
P9.29	Bus voltage upon 2nd fault		
P9.30	input terminal status upon 2nd fault		
P9.31	Output terminal status upon 2nd fault		
P9.32	AC drive status upon 2nd fault		
P9.33	power-on time upon 2nd fault		
P9.34	Running time upon 2nd fault		
P9.37	Frequency upon 1st fault		
P9.38	Current upon 1st fault		
P9.39	Bus voltage upon 1st fault		
P9.40	input terminal status upon 1st fault		
P9.41	output terminal status upon 1st fault		
P9.42	AC drive status 1st fault		
P9.43	power-on time upon 1st fault		
P9.44	Running time upon 1st fault		
P9.47	Fault protection action selection 1	Default	00000
	Setting Range	Unit's digit	Motor overload (OL1)
		0	Coast to stop
		1	Stop according to the stop mode
		2	Continue to run
		Ten's digit	Reserved
		Hundred's digit	Power output phase loss (LO) (the same as unit's digit)
		Thousand's digit	External equipment fault (EF) (the same as unit's digit)
Ten thousand's digit	Communication fault (CE) (the same as unit's digit)		

Chapter 4 Detailed Function Description

P9.48	Fault protection action selection 2		Default	00000
	Setting Range	Unit's digit	Reserved	
		0	Coast to stop	
		1	Switch over to V/F control, stop according to the stop mode	
		2	Switch over to V/F control, continue to run	
		Ten's digit	function code read-write abnormal(EEP)	
		0	Coast to stop	
		1	Stop according to the stop mode	
		Hundred's digit	Reserved	
		Thousand's digit	Reserved	
Ten thousand's digit		Accumulative running time reached (END1) (the same as unit's digit in P9.47)		
P9.49	Fault protection action selection 3		Default	00000
	Setting Range	Unit's digit	reserved	
		Ten's digit	reserved	
	Setting Range	Hundred's digit	Accumulative power-on time reached (END2) (the same as unit's digit in P9.47)	
		Thousand's digit	Load becoming 0 (LOAD)	
		0	Coast to stop	
		1	Stop according to the stop mode	
		2	Continue to run at 7% of rated motor frequency and resume to the set frequency if the load recovers	
Ten thousand's digit	PID feedback lost during running (PIDE) (the same as unit's digit in P9.47)			
P9.50	Reserved			

If "Coast to stop" is selected, the AC drive displays error code and directly stops.

If "Stop according to the stop mode" is selected, the AC drive displays alarm code and stops according to the stop mode. After stopping, the AC drive displays error code.

If "Continue to run" is selected, the AC drive continues to run and

displays alarm code. The running frequency is set in P9.54.

P9.54	Frequency selection for continuing to run		Default	0
	Setting Range	0	Current running frequency	
		1	Set frequency	
		2	Frequency upper limit	
		3	Frequency lower limit	
	4	Backup frequency upon abnormality		
P9.55	Backup frequency upon abnormality		Default	100.0%
	Setting Range	60.0%~100.0%		

If a fault occurs during the running of the AC drive and the handling of fault is set to "Continue to run", the AC drive displays alarm code and continues to run at the frequency set in P9.54.

The setting of P9.55 is a percentage relative to the maximum frequency.

P9.56	reserved			
P9.57	reserved			
P9.58	reserved			
P9.59	Action selection at instantaneous power failure		Default	0
	Setting Range	0	Invalid	
		1	Decelerate	
	2	Decelerate to stop		
P9.60	Action pause judging voltage at instantaneous power failure		Default	0.0%
	Setting Range	0.0%~100.0%		
P9.61	Voltage rally judging time at instantaneous power failure		Default	0.50s
	Setting Range	0.00s~100.00s		
P9.62	Action judging voltage at instantaneous power failure		Default	80.0%
	Setting Range	60.0%~100.0% (standard bus voltage)		

Upon instantaneous power failure or sudden voltage dip, the DC bus voltage of the AC drive reduces. This function enables the AC drive to compensate the DC bus voltage reduction with the load feedback energy by reducing the output frequency so as to keep the AC drive running continuously.

If P9.59 = 1, upon instantaneous power failure or sudden voltage

dip, the AC drive decelerates. Once the bus voltage resumes to normal, the AC drive accelerates to the set frequency. If the bus voltage remains normal for the time exceeding the value set in P9.61, it is considered that the bus voltage resumes to normal. If P9.59 = 2, upon instantaneous power failure or sudden voltage dip, the AC drive decelerates to stop.

Figure 4-22 AC drive action diagram upon instantaneous power failure

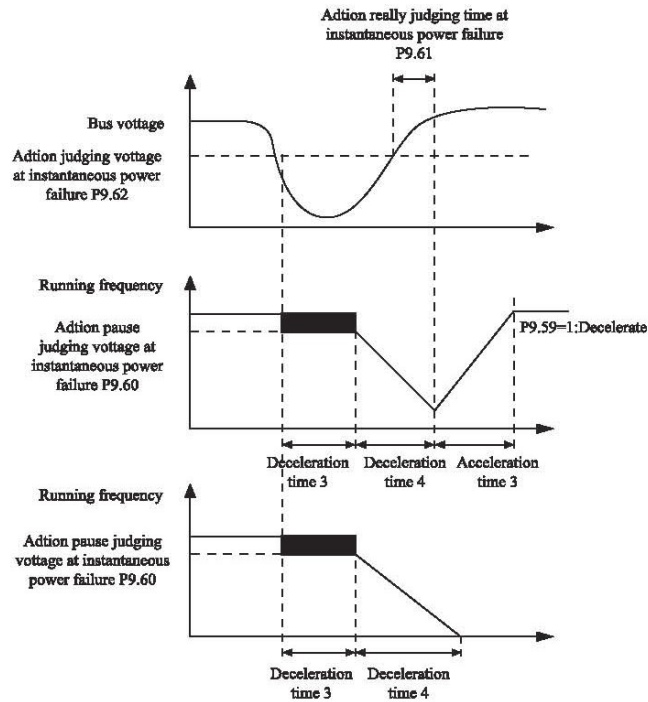

Figure 4-22 AC drive action diagram upon instantaneous power failure

P9.63	Protection upon load becoming 0	Default	0
	Setting Range	0	Disabled
		1	Enabled

Operation Instruction of NZ2000 Series Inverter

P9.64	Detection level of load becoming 0	Default	10.0%
	Setting Range	0.0%~100.0% (rated motor current)	
P9.65	Detection time of load becoming 0	Default	1.0s
	Setting Range	0.0s~60.0s	

If protection upon load becoming 0 is enabled, when the output current of the AC drive is lower than the detection level (P9.64) and the continuous time exceeds the detection time (P9.65), the output frequency of the AC drive automatically declines to 7% of the rated frequency. During the protection, the AC drive automatically accelerates to the set frequency if the load resumes to be normal.
P9.67~P9.70 Reserved

Group PA: Process Control PID Function

PID control is a general process control method. By performing proportional, integral and differential operations on the difference between the feedback signal and the target signal, it adjusts the output frequency and constitutes a feedback system to stabilize the controlled counter around the target value.

It is applied to process control such as flow control, pressure control and temperature control. The following figure shows the principle block diagram of PID control.

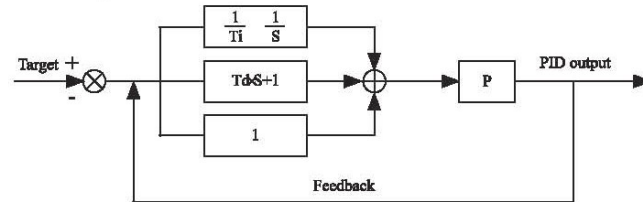

Figure 4-23 Principle block diagram of PID control

Chapter 4 Detailed Function Description

PA.00	PID setting source		Default	0
	Setting Range	0	PA.01	
		1	FIV	
		2	FIC	
		3	Reserved	
		4	PULSE setting (S3)	
		5	Communication setting	
6	Multi-reference			
PA.01	PID digital setting		Default	50.0%
	Setting Range		0.0%~100.0%	

PA.00 is used to select the channel of target process PID setting. The PID setting is a relative value and ranges from 0.0% to 100.0%. The PID feedback is also a relative value. The purpose of PID control is to make the PID setting and PID feedback the same.

PA.02	PID feedback source		Default	0
	Setting Range	0	FIV	
		1	FIC	
		2	Reserved	
		3	FIV-FIC	
		4	PULSE setting (S3)	
		5	Communication setting	
		6	FIV+FIC	
		7	MAX (FIV , FIC)	
8	MIN (FIV , FIC)			

This parameter is used to select the feedback signal channel of process PID.

The PID feedback is a relative value and ranges from 0.0% to 100.0%.

PA.03	PID action direction		Default	0
	Setting Range	0	Forward action	
1		Reverse action		

0: Forward action

When the feedback value is smaller than the PID setting, the AC drive's output frequency rises. For example, the winding tension control requires forward PID action.

1: Reverse action

When the feedback value is smaller than the PID setting, the AC drive's output frequency reduces. For example, the unwinding tension control requires reverse PID action. Note that this function

is influenced by reversing the multifunction terminal PID action. Pay attention in the application.

PA.04	PID setting feedback range	Default	1000
	Setting Range	0~65535	

This parameter is a non-dimensional unit. It is used for PID setting display (D0.15) and PID feedback display (D0.16).

Relative value 100% of PID setting feedback corresponds to the value of PA.04. If PA.04 is set to 2000 and PID setting is 100.0%, the PID setting display (D0.15) is 2000.

PA.05	Proportional gain Kp1	Default	20.0
	Setting Range	0.0~100.0	
PA.06	Integral time Ti1	Default	2.00s
	Setting Range	0.01s~10.00s	
PA.07	Differential time Td1	Default	0.000s
	Setting Range	0.00~10.000	

PA.05 (Proportional gain Kp1)

It decides the regulating intensity of the PID regulator. The higher the Kp1 is, the larger the regulating intensity is. The value 100.0 indicates when the deviation between PID feedback and PID setting is 100.0%, the adjustment amplitude of the PID regulator on the output frequency reference is the maximum frequency.

PA.06 (Integral time Ti1)

It decides the integral regulating intensity. The shorter the integral time is, the larger the regulating intensity is. When the deviation between PID feedback and PID setting is 100.0%, the integral regulator performs continuous adjustment for the time set in PA.06. Then the adjustment amplitude reaches the maximum frequency.

PA.07 (Differential time Td1)

It decides the regulating intensity of the PID regulator on the deviation change. The longer the differential time is, the larger the regulating intensity is. Differential time is the time within which the feedback value change reaches 100.0%, and then the adjustment amplitude reaches the maximum frequency.

PA.08	Cut-off frequency of PID reverse rotation	Default	2.00Hz
	Setting Range	0.00~maximum frequency	

In some situations, only when the PID output frequency is a negative value (AC drive reverse rotation), PID setting and PID feedback can be equal. However, too high reverse rotation frequency is prohibited

in some applications, and PA.08 is used to determine the reverse rotation frequency upper limit.

PA.09	PID deviation limit	Default	0.00%
	Setting Range	0.00%~100.00%	

If the deviation between PID feedback and PID setting is smaller than the value of PA.09, PID control stops. The small deviation between PID feedback and PID setting will make the output frequency stable and unchanging, especially effective for some closed-loop control applications.

PA.10	PID differential limit	Default	0.10%
	Setting Range	0.00%~100.00%	

It is used to set the PID differential output range. In PID control, the differential operation may easily cause system oscillation. Thus, the PID differential regulation is restricted to a small range. PA.10 is used to set the range of PID differential output.

PA.11	PID setting changing time	Default	0.00s
	Setting Range	0.00s~650.00s	

The PID setting changing time indicates the time required for PID setting changing from 0.0% to 100.0%. The PID setting changes linearly according to the changing time, reducing the impact caused by sudden setting change on the system.

PA.12	PID feedback filter time	Default	0.00s
	Setting Range	0.00s~60.00s	

PA.13	PID output filter time	Default	0.00s
	Setting Range	0.00s~60.00s	

PA.12 is used to filter the PID feedback, helping to reduce interference on the feedback but slowing down the response of the process closed-loop system.

PA.13 is used to filter the PID output frequency, helping to weaken sudden change of the AC drive output frequency but slowing down the response of the process closed-loop system.

PA.15	Proportional gain Kp2	Default	20.0
	Setting Range	0.0~100.0	

PA.16	Integral time Ti2	Default	2.00s
	Setting Range	0.01s~10.00s	

PA.17	Differential time Td2	Default	0.00s
	Setting Range	0.00~10.000	

Operation Instruction of NZ2000 Series Inverter

PA.18	PID parameter switchover condition		Default	0
	Setting Range	0	No switchover	
		1	Switchover via S	
		2	Automatic switchover based on deviation	
PA.19	PID parameter switchover deviation 1		Default	20%
	Setting Range	0.0%~PA.20		
PA.20	PID parameter switchover deviation 2		Default	80%
	Setting Range	PA.19~100.0%		

In some applications, PID parameters switchover is required when one group of PID parameters cannot satisfy the requirement of the whole running process. These parameters are used for switchover between two groups of PID parameters.

Regulator parameters PA.15 to PA.17 are set in the similar way as PA.05 to PA.07.

The switchover can be implemented either via S terminal or automatically implemented based on the deviation.

If you select switchover via S terminal, the S must be allocated with function 43 "PID parameter switchover". If the S is OFF, group 1 (PA.05 to PA.07) is selected. If the S is ON, group 2 (PA.15 to PA.17) is selected.

If you select automatic switchover, when the absolute value of the deviation between PID feedback and PID setting is smaller than the value of PA.19, PID parameter selects group 1. When the absolute value of the deviation between PID feedback and PID setting is higher than the value of PA.20, PID parameter selects group 2. When the deviation is between PA.19 and PA.20, the PID parameters are the linear interpolated value of the two groups of parameter values.

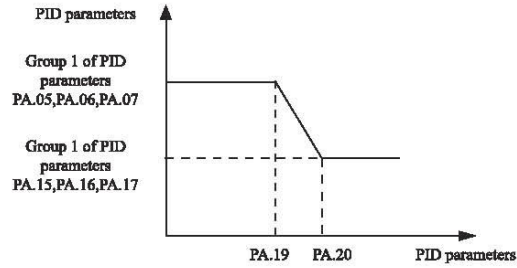

Figure 4-24 PID parameters switchover

PA.21	PID initial value	Default	0.0%
	Setting Range	0.0%~100.0%	
PA.22	PID initial value holding time	Default	0.00s
	Setting Range	0.00s~650.00s	

When the AC drive starts up, the PID starts closed-loop algorithm only after the PID output is fixed to the PID initial value (PA.21) and lasts the time set in PA.22.

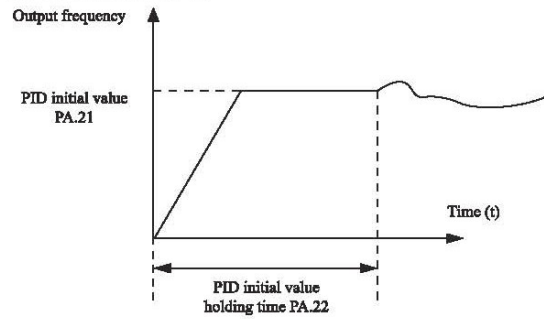

Figure 4-25 PID initial value function

PA.23	Maximum deviation between two PID outputs in forward direction	Default	1.00%
	Setting Range	0.00%~100.00%	

Operation Instruction of NZ2000 Series Inverter

PA.24	Maximum deviation between two PID outputs in reverse direction	Default	1.00%
	Setting Range	0.00%~100.00%	

This function is used to limit the deviation between two PID outputs (2 ms per PID output) to suppress the rapid change of PID output and stabilize the running of the AC drive.

PA.23 and PA.24 respectively correspond to the maximum absolute value of the output deviation in forward direction and in reverse direction.

PA.25	PID integral property		Default	00
	Setting Range	Unit's digit	Integral separated	
		0	Invalid	
		1	Valid	
		Ten's digit	Whether to stop integral operation when the output reaches the limit	
		0	Continue integral operation	
1		Stop integral operation		

Integral separated

If set the integral separated valid, the PID integral operation stops when the X allocated with function 38 "PID integral pause" is effective. In this case, only proportional and differential operations take effect.

If it is set invalid, integral separated remains invalid no matter whether the S allocated with function 38 "PID integral pause" is ON or not.

Whether to stop integral operation when the output reaches the limit.

If "Stop integral operation" is selected, the PID integral operation stops, which may help to reduce the PID overshoot.

PA.26	Detection value of PID feedback loss	Default	0.0%
	Setting Range	0.0%: Not judging feedback loss 0.1%: 100.0%	
PA.27	Detection time of PID feedback loss	Default	0.0s
	Setting Range	0.0s~20.0s	

These parameters are used to judge whether PID feedback is lost. If the PID feedback is smaller than the value of PA.26 and the continuous time exceeds the value of PA.27, the AC drive reports

PIDE and acts according to the selected fault protection action.

PA.28	PID operation at stop	Default	0
	Setting Range	0	No PID operation at stop
		1	PID operation at stop

These parameters are used to judge whether PID feedback is lost. If the PID feedback is smaller than the value of PA.26 and the lasting time exceeds the value of PA.27, the AC drive reports PIDE and acts according to the selected fault protection action.

Group Pb: Swing Frequency, Fixed Length and Count

The swing frequency function is applied to the textile and chemical fiber fields and the applications where traversing and winding functions are required.

The swing frequency function indicates that the output frequency of the AC drive swings up and down with the set frequency as the center. The trace of running frequency at the time axis is shown in the following figure.

The swing amplitude is set in Pb..00 and Pb.01. When Pb.01 is set to 0, the swing amplitude is 0 and the swing frequency does not take effect.

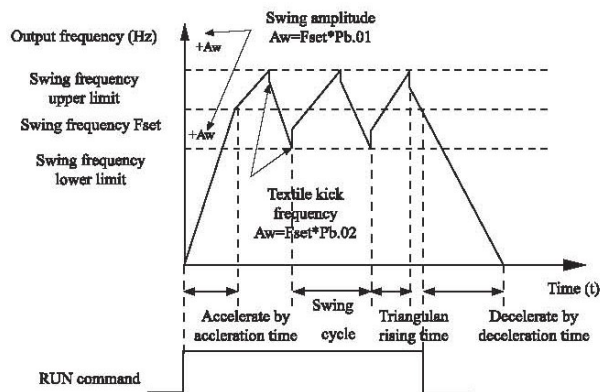

Figure 4-26 Swing frequency control

Operation Instruction of NZ2000 Series Inverter

Pb.00	Swing frequency setting mode		Default	0
	Setting Range	0	Relative to the central frequency	
		1	Relative to the maximum frequency	

This parameter is used to select the base value of the swing amplitude.

0: Relative to the central frequency (P0.03 frequency source selection)

It is variable swing amplitude system. The swing amplitude varies with the central frequency (set frequency).

1: Relative to the maximum frequency (P0.12 maximum output frequency)

It is fixed swing amplitude system. The swing amplitude is fixed.

Pb.01	Swing frequency amplitude		Default	0.0%
	Setting Range		0.0%~100.0%	
Pb.02	Jump frequency amplitude		Default	0.0%
	Setting Range		0.0%~50.0%	

This parameter is used to determine the swing amplitude and jump frequency amplitude.

The swing frequency is limited by the frequency upper limit and frequency lower limit.

If relative to the central frequency (Pb.00 = 0), the actual swing amplitude AW is the calculation result of P0.03 (Frequency source selection) multiplied by Pb.01. If relative to the maximum frequency (Pb.00 = 1), the actual swing amplitude AW is the calculation result of P0.12 (Maximum frequency) multiplied by Pb.01. Jump frequency = Swing amplitude AW × Pb.02 (Jump frequency amplitude). If relative to the central frequency (Pb.00 = 0), the jump frequency is a variable value. If relative to the maximum frequency (Pb.00 = 1), the jump frequency is a fixed value.

The swing frequency is limited by the frequency upper limit and frequency lower limit.

Pb.03	Swing frequency cycle		Default	10.0s
	Setting Range		0.1s~3000.0s	
Pb.04	Triangular wave rising time coefficient		Default	50.0%
	Setting Range		0.1%~100.0%	

Swing frequency cycle: the time of a complete swing frequency cycle.

Chapter 4 Detailed Function Description

Pb.04 specifies the time percentage of triangular wave rising time to Pb.03 (Swing frequency cycle).

Triangular wave rising time = Pb.03 (Swing frequency cycle) x Pb.04 (Triangular wave rising time coefficient, unit: s)

Triangular wave falling time = Pb.03 (Swing frequency cycle) x (1–

Pb.04 Triangular wave rising time coefficient ,unit: s)

Pb.05	Set length	Default	1000m
	Setting Range	0m~65535m	
Pb.06	Actual length	Default	0m
	Setting Range	0m~65535m	
Pb.07	Number of pulses per meter	Default	100.0
	Setting Range	0.1~6553.5	

The preceding parameters are used for fixed length control.

The length information is collected by multifunction digital terminals. Pb.06 (Actual length) is calculated by dividing the numbers of pulses collected by the S terminal by Pb.07 (Number of pulses each meter).

When the actual length Pb.06 exceeds the set length in Pb.05, the M01 terminal allocated with function 10 (Length reached) becomes ON.

During the fixed length control, the length reset operation can be performed via the S terminal allocated with function 28. For details, see the descriptions of P5.00 to P5.05.

Allocate corresponding S terminal with function 27 (Length count input) in applications. If the pulse frequency is high, S3 must be used.

Pb.08	Set count value	Default	1000
	Setting Range	1~65535	
Pb.09	Designated count value	Default	1000
	Setting Range	1~65535	

The count value needs to be collected by multi-function input terminals. Allocate the corresponding input terminals with function 25 (Counter input) in applications. If the pulse frequency is high, S3 must be used.

When the count value reaches the set count value (Pb.08), the M01 terminal allocated with function 8 (Set count value reached) becomes ON. Then the counter stops counting.

When the counting value reaches the designated counting value

(Pb.09), the M01 terminal allocated with function 9 (Designated count value reached) becomes ON. Then the counter continues to count until the set count value is reached.

Pb.09 should be equal to or smaller than Pb.08.

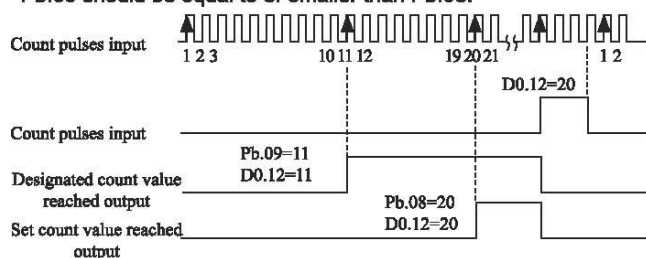

Figure 4-27 the set count value reached and designated count value

Group PC: Multi-Reference and Simple PLC Function

The NZ2000 multi-reference has more rich functions than multi-speed. Besides multi-speed, it can be used as the setting source of the V/F separated voltage source and setting source of process PID. In addition, the multi-reference is relative value.

The simple PLC function is different from the NZ2000 user programmable function. Simple PLC can only complete simple combination of multi-reference, while the user programmable function is richer and more practical. For details, see the descriptions of group PC.

PC.00	multi-reference 0	Default	0.0%
	Setting Range	-100.0%~100.0%	
PC.01	multi-reference 1	Default	0.0%
	Setting Range	-100.0%~100.0%	
PC.02	multi-reference 2	Default	0.0%
	Setting Range	-100.0%~100.0%	
PC.03	multi-reference 3	Default	0.0%
	Setting Range	-100.0%~100.0%	
PC.04	multi-reference 4	Default	0.0%
	Setting Range	-100.0%~100.0%	
PC.05	multi-reference 5	Default	0.0%
	Setting Range	-100.0%~100.0%	
PC.06	multi-reference 6	Default	0.0%
	Setting Range	-100.0%~100.0%	

Chapter 4 Detailed Function Description

PC.07	multi-reference 7	Default	0.0%
	Setting Range	-100.0%~100.0%	
PC.08	multi-reference 8	Default	0.0%
	Setting Range	-100.0%~100.0%	
PC.09	multi-reference 9	Default	0.0%
	Setting Range	-100.0%~100.0%	
PC.10	multi-reference 10	Default	0.0Hz
	Setting Range	-100.0%~100.0%	
PC.11	multi-reference 11	Default	0.0%
	Setting Range	-100.0%~100.0%	
PC.12	multi-reference 12	Default	0.0%
	Setting Range	-100.0%~100.0%	
PC.13	multi-reference 13	Default	0.0%
	Setting Range	-100.0%~100.0%	
PC.14	multi-reference 14	Default	0.0%
	Setting Range	-100.0%~100.0%	
PC.15	Reference 15	Default	0.0%
	Setting Range	-100.0%~100.0%	

Multi-reference can be used in three occasions : as the source of frequency, V/F separated voltage source and the setting source of process PID. The multi-reference is relative value and ranges from -100.0% to 100.0%.

As frequency source, it is a percentage relative to the maximum frequency. As V/F separated voltage source, it is a percentage relative to the rated motor voltage.

As process PID setting source, it does not require conversion.

Multi-reference can be switched over based on different states of multifunction digital S terminals. For details, see the descriptions of group P5.

PC.16	Simple PLC running mode	Default	0
	Setting Range	0	Stop after the AC drive runs one cycle
		1	Keep final values after the AC drive runs one cycle
	2	Repeat after the AC drive runs one cycle	

0: Stop after the AC drive runs one cycle

The AC drive stops after running one cycle, and will not start up until receiving another command.

1: Keep final values after the AC drive runs one cycle

The AC drive keeps the final running frequency and direction after running one cycle.

2: Repeat after the AC drive runs one cycle

The AC drive automatically starts another cycle after running one cycle, and will not stop until receiving the stop command. Simple PLC function has two effects: the frequency source or V/F separated voltage source.

When simple PLC is used as the frequency source, whether parameter values of PC.00 to PC.15 are positive or negative determines the running direction. If the parameter values are negative, it indicates that the AC drive runs in reverse direction.

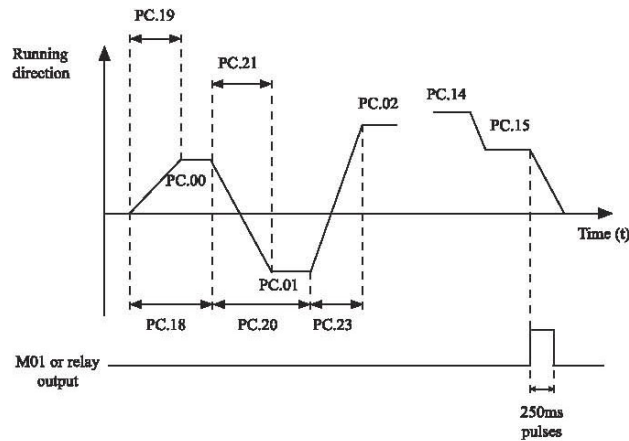

Figure 4-28 Simple PLC when used as frequency source

As the frequency source, PLC has three running modes, as V/F separated voltage source, it doesn't have the three modes. Among them,

0: Stop after the AC drive runs one cycle

The AC drive stops after running one cycle, and will not start up until receiving another command.

1: Keep final values after the AC drive runs one cycle. The AC drive keeps the final running frequency and direction after running one cycle.

2: Repeat after the AC drive runs one cycle

The AC drive automatically starts another cycle after running one cycle, and will not stop until receiving the stopping command.

Chapter 4 Detailed Function Description

PC.17	Simple PLC retentive selection		Default	00
	Setting Range	Unit's digit	Retentive upon power failure	
		0	No	
		1	Yes	
		Ten's digit	Retentive upon stop	
	0	No		
1	Yes			

PLC retentive upon power failure indicates that the AC drive memorizes the PLC running moment and running frequency before power failure and will continue to run from the memorized moment after it is powered on again. If the unit's digit is set to 0, the AC drive restarts the PLC process after it is powered on again.

PLC retentive upon stopping indicates that the AC drive records the PLC running moment and running frequency upon stopping and will continue to run from the recorded moment after it starts up again. If the ten's digit is set to 0, the AC drive restarts the PLC process after it starts up again.

PC.18	Running time of simple PLC reference 0		Default	0.0s (h)
	Setting Range	0.0s (h)~6553.5s (h)		
PC.19	Acceleration/deceleration time of simple PLC reference 0		Default	0
	Setting Range	0~3		
PC.20	Running time of simple PLC reference 1		Default	0.0s (h)
	Setting Range	0.0s (h) ~6553.5s (h)		
PC.21	Acceleration/deceleration time of simple PLC reference 1		Default	0
	Setting Range	0~3		
PC.22	Running time of simple PLC reference 2		Default	0.0s (h)
	Setting Range	0.0s (h) ~6553.5s (h)		
PC.23	Acceleration/deceleration time of simple PLC reference 2		Default	0
	Setting Range	0~3		
PC.24	Running time of simple PLC reference 3		Default	0.0s (h)
	Setting Range	0.0s (h) ~6553.5s (h)		
PC.25	Acceleration/deceleration time of simple PLC reference 3		Default	0
	Setting Range	0~3		
PC.26	Running time of simple PLC reference 4		Default	0.0s (h)
	Setting Range	0.0s (h) ~6553.5s (h)		

Operation Instruction of NZ2000 Series Inverter

PC.27	Acceleration/deceleration time of simple PLC reference 4	Default	0
	Setting Range	0~3	
PC.28	Running time of simple PLC reference 5	Default	0.0s (h)
	Setting Range	0.0s (h) ~6553.5s (h)	
PC.29	Acceleration/deceleration time of simple PLC reference 5	Default	0
	Setting Range	0~3	
PC.30	Running time of simple PLC reference 6	Default	0.0s (h)
	Setting Range	0.0s (h) ~6553.5s (h)	
PC.31	Acceleration/deceleration time of simple PLC reference 6	Default	0
	Setting Range	0~3	
PC.32	Running time of simple PLC reference 7	Default	0.0s (h)
	Setting Range	0.0s (h) ~6553.5s (h)	
PC.33	Acceleration/deceleration time of simple PLC reference 7	Default	0
	Setting Range	0~3	
PC.34	Running time of simple PLC reference 8	Default	0.0s (h)
	Setting Range	0.0s (h) ~6553.5s (h)	
PC.35	Acceleration/deceleration time of simple PLC reference 8	Default	0
	Setting Range	0~3	
PC.36	Running time of simple PLC reference 9	Default	0.0s (h)
	Setting Range	0.0s (h) ~6500.0s (h)	
PC.37	Acceleration/deceleration time of simple PLC reference 9	Default	0
	Setting Range	0~3	
PC.38	Running time of simple PLC reference 10	Default	0.0s (h)
	Setting Range	0.0s (h) ~6500.0s (h)	
PC.39	Acceleration/deceleration time of simple PLC reference 10	Default	0
	Setting Range	0~3	
PC.40	Running time of simple PLC reference 11	Default	0.0s (h)
	Setting Range	0.0s (h) ~6500.0s (h)	
PC.41	Acceleration/deceleration time of simple PLC reference 11	Default	0
	Setting Range	0~3	
PC.42	Running time of simple PLC reference 12	Default	0.0s (h)
	Setting Range	0.0s (h) ~6500.0s (h)	

Chapter 4 Detailed Function Description

PC.43	Acceleration/deceleration time of simple PLC reference 12		Default	0
	Setting Range	0~3		
PC.44	Running time of simple PLC reference 13		Default	0.0s (h)
	Setting Range	0.0s (h) ~6500.0s (h)		
PC.45	Acceleration/deceleration time of simple PLC		Default	0
	Setting Range	0~3		
PC.46	Running time of simple PLC reference 14		Default	0.0s (h)
	Setting Range	0.0s (h) ~6500.0s (h)		
PC.47	Acceleration/deceleration time of simple PLC		Default	0
	Setting Range	0~3		
PC.48	Running time of simple PLC reference 15		Default	0.0s (h)
	Setting Range	0.0s (h) ~6500.0s (h)		
PC.49	Acceleration/deceleration time of simple PLC reference 15		Default	0
	Setting Range	0~3		
PC.50	Time unit of simple PLC		Default	0
	Setting Range	0	S (second)	
		1	h (hour)	
PC.51	Reference 0 source		Default	0
	Setting Range	0	Set by PC.00	
		1	FIV	
		2	FIC	
		3	Reserved	
		4	PULSE setting	
		5	PID	
		6	Set by preset frequency (P0.10), modified via terminal UP/DOWN	

It determines the setting channel of reference 0. You can perform convenient switchover between the setting channels. When multi-reference or simple PLC is used as frequency source, the switchover between two frequency sources can be realized easily.

Group PD: Communication Parameters

Please refer to the "NZ2000 communication protocol"

Group PP: User-Defined Function Codes

PP.00	User password	Default	0
	Setting Range	0~65535	

If it is set to any non-zero number, the password protection function is enabled. After a password has been set and taken effect, you must input the correct password in order to enter the menu. If the entered password is incorrect you cannot view or modify parameters. If PP.00 is set to 00000, the previously set user password is cleared, and the password protection function is disabled.

PP.01	Restore default settings	Default	0
	Setting Range	0	No operation
		1	Restore factory settings except motor parameters
	2	Clear records	

1: Restore default settings except motor parameters

If PP.01 is set to 1, most function codes are restored to the default settings except motor parameters, frequency reference decimal point (P0.22, fault records, accumulative running time (P7.09), accumulative power-on time (P7.13) and accumulative power consumption (P7.14).

2: Clear records

If PP.01 is set to 2, the fault records, accumulative running time (P7.09), accumulative power-on time (P7.13) and accumulative power consumption (P7.14) are cleared.

Group C0: Torque Control and Restricting Parameters

C0.00	Speed/Torque control selection	Default	0
	Setting Range	0	Speed control
		1	Torque control

It is used to select the AC drive's control mode: speed control or torque control.

The NZ2000 provides S terminals with two torque related functions, fTorque control prohibited (function 29)and Speed control/Torque control switchover(function 46). The two S terminals need to be used together with C0.00 to implement speed control/torque control switchover.

If the S terminal allocated with function 46 (Speed control/Torque control switchover) is OFF, the control mode is determined by C0.00. If the S terminal allocated with function 46 is ON, the control mode is to reverse the value of C0-00. However, if the torque control prohibited terminal is ON, the AC drive is fixed to run in the speed control mode.

C0.01	Torque setting source in torque control		Default	0
	Setting Range	0	Digital setting (C0.03)	
		1	FIV	
		2	FIC	
		3	Reserved	
		4	PULSE setting	
		5	Communication setting	
		6	MIN (FIV,FIC)	
7		MAX (FIV,FIC)		
C0.03	Torque digital setting in torque control		Default	150%
	Setting Range		-200.0%~200.0%	

C0.01 is used to set the torque setting source. There are a total of eight torque setting sources. The torque setting is a relative value. 100.0% corresponds to the AC drive's rated torque. The setting range is -200.0% to 200.0%, indicating the AC drive's maximum torque is twice of the AC drive's rated torque.

When the torque setting using 1 ~ 7, communication, analog input and pulse input. The data format is -100.00% to 100.00%. 100% corresponds to the value of C0.03.

C0.05	Forward maximum frequency in torque control		Default	50.00Hz
	Setting Range		0.00Hz~maximum frequency	
C0.06	Reverse maximum frequency in torque control		Default	50.00Hz
	Setting Range		0.00Hz~maximum frequency	

This two parameters are used to set the maximum frequency in forward or reverse rotation in torque control mode.

In torque control, if the load torque is smaller than the motor output torque, the motor's rotational speed will rise continuously. To avoid runaway of the mechanical system, the motor maximum rotating speed must be limited in torque control.

You can implement continuous change of the maximum frequency

in torque control dynamically by controlling the frequency upper limit.

C0.07	Acceleration time in torque control	Default	0.00s
	Setting Range	0.00s~650.00s	
C0.08	Deceleration time in torque control	Default	0.00s
	Setting Range	0.00s~650.00s	

In torque control, the difference between the motor output torque and the load torque determines the speed change rate of the motor and load. The motor rotational speed may change quickly and this will result in noise or too large mechanical stress. The setting of acceleration/deceleration time in torque control makes the motor rotational speed change smoothly.

However, in applications requiring rapid torque response, set the acceleration/deceleration time in torque control to 0.00s. For example, two AC drives are connected to drive the same load. To balance the load allocation, set one AC drive as master in speed control and the other as slave in torque control. The slave receives the master's output torque as the torque command and must follow the master rapidly. In this case, the acceleration/deceleration time of the slave in torque control is set to 0.0s.

Group C5: Control Optimization Parameters

C5.00	PWM switchover frequency upper limit	Default	12.00Hz
	Setting Range	0.00Hz~15Hz	

This parameter is valid only for V/F control.

It is used to determine the wave modulation mode in V/F control of asynchronous motor.

If the frequency is lower than the value of this parameter, the waveform is 7-segment continuous modulation. If the frequency is higher than the value of this parameter, the waveform is 5-segment intermittent modulation.

The 7-segment continuous modulation causes more loss to switches of the AC drive but smaller current ripple. The 5-segment intermittent modulation causes less loss to switches of the AC drive but larger current ripple. This may lead to motor running instability at high frequency. Do not modify this parameter generally.

For instability of V/F control, refer to parameter P4.11. For loss to

Chapter 4 Detailed Function Description

AC drive and temperature rise, refer to parameter P0.17.

C5.01	PWM modulation mode	Default	0
	Setting Range	0	0: Asynchronous modulation
		1	1: Synchronous modulation

Only V/F control is effective. asynchronous modulation is used when the output frequency is high(over 100HZ),conducive to the quality of the output voltage.

C5.02	Dead compensation way	Default	1
	Setting Range	0	No compensation
		1	compensation mode 1
2		compensation mode 2	

It doesn't have to modify generally.

C5.03	Random PWM depth	Default	0
	Setting Range	0	Random PWM invalid
		1-10	PWM carrier frequency random depth

Random PWM depth is set to improve the motor's noise,reduce electromagnetic interference.

C5.04	Fast current limiting open	Default	1
	Setting Range	0	Not open
		1	Open

Opening fast current limiting can reduce overcurrent fault,make the inverter work normally. Opening fast current limiting for a long time ,can make the inverter overheat,Report a fault CBC.CBC represents fast current limiting fault and need to stop.

C5.05	Current detection compensation	Default	5
	Setting Range	0~100	

Used to set current detection compensation, don't recommend to modify.

C5.06	Undervoltage setting	Default	100%
	Setting Range	60.0~140.0%	

Used to set the voltage of inverter's lack voltage fault LU,Different voltage levels of inverter's 100%,corresponding to different voltages, Respectively single-phase 220V or three-phase 220V: three-phase 380V:350;three-phase 690V:650V.

Operation Instruction of NZ2000 Series Inverter

C5.07	SFVC optimization mode selection	Default	1
	Setting Range	0	No optimization
		1	Optimization mode 1
		2	Optimization mode 2

1: Optimization mode 1

It is used when the requirement on torque control linearity is high.

2: Optimization mode 2

It is used for the requirement on speed stability is high.

Group C6: FI Curve Setting(FI is FIV or FIC)

C6.00	FI curve 4 minimum input	Default	0.00V
	Setting Range	-10.00V~C6.02	
C6.01	Corresponding setting of FI curve 4 minimum input	Default	0.0%
	Setting Range	-100.0%~100.0%	
C6.02	FI curve 4 inflexion 1 input	Default	3.00V
	Setting Range	C6.00~C6.04	
C6.03	Corresponding setting of FI curve 4 inflexion 1 input	Default	30.0%
	Setting Range	-100.0%~100.0%	
C6.04	FI curve 4 inflexion 2 input	Default	6.00V
	Setting Range	C6.02~C6.06	
C6.05	Corresponding setting of FI curve 4 inflexion 2 input	Default	60.0%
	Setting Range	-100.0%~100.0%	
C6.06	FI curve 4 maximum input	Default	10.00V
	Setting Range	C6.06~10.00V	
C6.07	Corresponding setting of FI curve 4 maximum input	Default	100.0%
	Setting Range	-100.0%~100.0%	
C6.08	FI curve 5 minimum input	Default	0.00V
	Setting Range	-10.00V~C6.10	
C6.09	Corresponding setting of FI curve 5 minimum input	Default	0.0%
	Setting Range	-100.0%~100.0%	
C6.10	FI curve 5 inflexion 1 input	Default	3.00V
	Setting Range	C6.08~C6.12	
C6.11	Corresponding setting of FI curve 5 inflexion 1 input	Default	30.0%
	Setting Range	-100.0%~100.0%	
C6.12	FI curve 5 inflexion 2 input	Default	6.00V
	Setting Range	C6.10~C6.14	

C6.13	Corresponding setting of F1 curve 5 inflexion 2 input	Default	60.0%
	Setting Range	-100.0%~100.0%	
C6.14	F1 curve 5 maximum input	Default	10.00V
	Setting Range	C6.14~10.00V	
C6.15	Corresponding setting of F1 curve 5 maximum input	Default	100.0%
	Setting Range	-100.0%~100.0%	

The function of curve 4 and curve 5 is similar to that curve 1 to curve 3, but curve 1 to curve 3 are lines, and curve 4 and curve 5 are 4-point curves, implementing more flexible corresponding relationship. The schematic diagram of curve 4 and curve 5 is shown in the following figure.

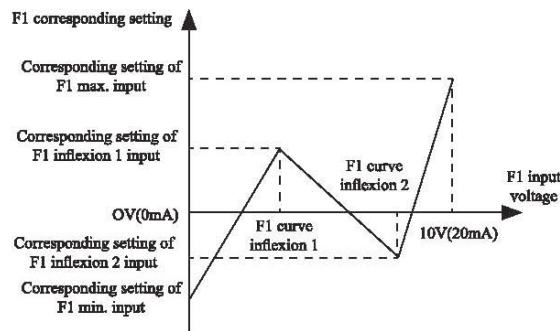

Figure 4-29 Schematic diagram curve 4 and curve 5

When setting curve 4 and curve 5, note that the curve's minimum input voltage, inflexion 1 voltage, inflexion 2 voltage and maximum voltage must be in increment order.

P5.33 (F1 curve selection) is used to determine how to select curve for FIV to FIC from the five curves.

C6.16	Jump point of FIV input corresponding setting	Default	0.0%
	Setting Range	-100.0%~100.0%	
C6.17	Jump amplitude of FIV input corresponding setting	Default	0.5%
	Setting Range	0.0%~100.0%	
C6.18	Jump point of FIC input corresponding setting	Default	0.0%
	Setting Range	-100.0%~100.0%	
C6.19	Jump amplitude of FIC input corresponding setting	Default	0.5%
	Setting Range	0.0%~100.0%	

The analog input terminals (FIV to FIC) of the NZZ000 all support

the corresponding setting jump function, which fixes the analog input corresponding setting at the jump point when analog input corresponding setting jumps around the jump range.

For example, FIV input voltage jumps around 5.00 V and the jump range is 4.90–5.10V. FIV minimum input 0.00 V corresponds to 0.0% and maximum input 10.00 V corresponds to 100.0%. The detected FIV input corresponding setting varies between 49.0% and 51.0%.

If you set C6.16 to 50.0% and C6.17 to 1.0%, then the obtained stable input FIV input corresponding setting is fixed to 50.0% after the jump function, eliminating the fluctuation effect.

Function Code	Description	Range	Default value
C9.00	PID Sleep frequency	0 ~ P0.12	00.00 Hz
C9.01	PID Sleep Time	0 ~ 5000.0S	10.0 S
C9.02	PID wake-up value	0 ~ 100.0 %	60.0 %

Function Description:

Run, the output frequency <PID sleep frequency (C9.00) and lasted longer than C9.01 and the feedback value> 90% of a given value. The frequency is reduced to 0, from going to sleep. Sleep feedback <C9.02 * given value, the inverter exits Sleep, the output frequency is increased. Sleep, temperature less than 42 degrees, the fan will stop.

Group CC: FI/FO Correction

CC.00	FIV measured voltage 1	Default	Factory-corrected
	Setting Range	0.500V~4.000V	
CC.01	FIV displayed voltage 1	Default	Factory-corrected
	Setting Range	0.500V~4.000V	
CC.02	FIV measured voltage 2	Default	Factory-corrected
	Setting Range	6.000V~9.999V	
CC.03	FIV displayed voltage 2	Default	Factory-corrected
	Setting Range	6.000V~9.999V	
CC.04	FIC measured voltage 1	Default	Factory-corrected
	Setting Range	0.500V~4.000V	
CC.05	FIC displayed voltage 1	Default	Factory-corrected
	Setting Range	0.500V~4.000V	
CC.06	FIC measured voltage 2	Default	Factory-corrected
	Setting Range	6.000V~9.999V	
CC.07	FIC displayed voltage 2	Default	Factory-corrected
	Setting Range	-9.999V~10.000V	

These parameters are used to correct the FI to eliminate the impact of FI zero offset and gain.

They have been corrected upon delivery. When you resume the factory values, these parameters will be restored to the factory-corrected values. Generally, you need not perform correction in the applications.

Measured voltage indicates the actual output voltage value measured by instruments such as the multimeter. Displayed voltage indicates the voltage display value sampled by the AC drive. For details, refer to D0.21, D0.22 .During correction, send two voltage values to each FI terminal, and save the measured values and displayed values to the function codes CC.00 to CC.07. Then the AC drive will automatically perform FI zero offset and gain correction.

CC.12	FOV target voltage 1	Default	Factory-corrected
	Setting Range	0.500V~4.000V	
CC.13	FOV measured voltage 1	Default	Factory-corrected
	Setting Range	0.500V~4.000V	
CC.14	FOV target voltage 2	Default	Factory-corrected
	Setting Range	6.000V~9.999V	
CC.15	FOV measured voltage 2	Default	Factory-corrected
	Setting Range	6.000V~9.999V	
CC.16	Reserved		
CC.17	Reserved		
CC.18	Reserved		
CC.19	Reserved		

These parameters are used to correct the FOV.

They have been corrected upon delivery. When you resume the factory values, these parameters will be restored to the factory-corrected values. You need not perform correction in the applications.

Target voltage indicates the theoretical output voltage of the AC drive. Measured voltage indicates the actual output voltage value measured by instruments such as the multimeter.

Group D0: Monitoring Parameters

Group D0 is used to monitor the AC drive's running state. You can view the parameter values by using operation panel, convenient for on-site commissioning, or from the host computer by means of

communication .

D0.00 to D0.31 are the monitoring parameters in the running and stopping state defined by P7.03 and P7.04.

For more details, see Table

Parameters of Group D0:

Function Code	Parameter Name	Unit
D0.00	Running frequency (Hz)	0.01Hz
D0.01	Set frequency (Hz)	0.01Hz
D0.02	Bus voltage (V)	0.1V
D0.03	Output voltage (V)	1V
D0.04	Output current (A)	0.01A
D0.05	Output power (kW)	0.1kW
D0.06	Output torque (%)	0.1%
D0.07	S input state	1
D0.08	M01 output state	1
D0.09	Reserved	
D0.10	FIC voltage (V)	0.01V
D0.11	Reserved	
D0.12	Count value	1
D0.13	Length value	1
D0.14	Load speed display	1
D0.15	PID setting	1
D0.16	PID feedback	1
D0.17	PLCstage	1
D0.18	Input pulse frequency	0.01kHz
D0.19	Reserved	
D0.20	Remaining running time	0.1Min
D0.21	FIV voltage before correction	0.001V
D0.22	FIC voltage before correction	0.001V
D0.23	Reserved	
D0.24	Linear speed	1m/Min
D0.25	the current power-on time	1Min
D0.26	The current running time	0.1Min

Chapter 4 Detailed Function Description

Function Code	Parameter Name	Unit
D0.27	Pulse input frequency	1Hz
D0.28	Communication setting value	0.01%
D0.29	Reserved	
D0.30	Main frequency X	0.01Hz
D0.31	Auxiliary frequency Y	0.01Hz
D0.32	View any memory address values	
D0.33	Reserved	
D0.34	Reserved	
D0.35	Target torque	0.1%
D0.36	Reserved	
D0.37	Power factor angle	0.1
D0.38	Reserved	
D0.39	Target voltage upon V/F separation	1V
D0.40	Output voltage upon V/F separation	1V
D0.41	Reserved	
D0.42	Reserved	
D0.43	Reserved	
D0.44	Reserved	
D0.45	Fault information	0

Chapter 5 Fault checking and ruled out

5.1 Fault alarm and countermeasures

NZ2000 inverter with a total of 28 warning information and the protection function, once the failure, protection function, inverter to stop output, inverter fault relay contact action, and in the inverter fault code shown on the display panel. the user can check himself according to the tips before seeking service, analyze the cause of the problem, find out the solution. If belong to the dotted line frame stated reason, please seek service, with your purchased inverter agents or direct contact with our company.

21 warning information OUOC is overcurrent or overvoltage signals for hardware, in most cases the hardware overvoltage fault cause OUOC alarm.

Fault Name	Display of Panel	Possible Causes	Solutions
Inverter unit protection	OC	1: The output circuit is grounded or short circuited. 2: The connecting cable of the motor is too long. 3: The module overheats. 4: The internal connections become loose. 5: The main control board is faulty. 6: The drive board is faulty. 7: The inverter module is faulty	1: Eliminate external faults. 2: Install a reactor or an output filter. 3: Check the air filter and the cooling fan. 4: Connect all cables Property. 5,6,7: Looking for technical support

Chapter 5 Fault checking and ruled out

Fault Name	Display of Panel	Possible Causes	Solutions
Overcurrent during acceleration	OC1	<ol style="list-style-type: none"> 1: The output circuit is grounded or short circuited. 2: Motor auto-tuning is not Performed. 3: The acceleration time is too Short. 4: Manual torque boost or V/F curve is not appropriate. 5: The voltage is too low. 6: The startup operation is performed on the rotating motor. 7: A sudden load is added during Acceleration. 8: The AC drive model is of too small power class. 	<ol style="list-style-type: none"> 1: Eliminate external faults. 2: Perform the motor auto-tuning. 3: Increase the acceleration time. 4: Adjust the manual torque boost or V/F curve. 5: Adjust the voltage to normal range. 6: Select rotational speed tracking restart or start the motor after it stops. 7: Remove the added load. 8: Select an AC drive of higher power class.
Overcurrent during acceleration	OC2	<ol style="list-style-type: none"> 1: The output circuit is grounded or short circuited. 2: Motor auto-tuning is not performed. 3: The deceleration time is too Short. 4: The voltage is too low. 5: A sudden load is added during Deceleration. 6: The braking unit and braking resistor are not installed. 	<ol style="list-style-type: none"> 1: Eliminate external faults. 2: Perform the motor auto-tuning. 3: Increase the deceleration time. 4: Adjust the voltage to normal range. 5: Remove the added load. 6: Install the braking unit and braking resistor.
Overcurrent at constant speed	OC3	<ol style="list-style-type: none"> 1: The output circuit is grounded or short circuited. 2: Motor auto-tuning is not performed. 3: The voltage is too low. 4: A sudden load is added during operation. 5: The AC drive model is of too small power class. 	<ol style="list-style-type: none"> 1: Eliminate external faults. 2: Perform the motor auto-tuning. 3: Adjust the voltage to normal range. 4: Remove the added load. 5: Select an AC drive of higher power class.

Operation Instruction of NZ2000 Series Inverter

Fault Name	Display of Panel	Possible Causes	Solutions
Overvoltage during acceleration	OU1	<ol style="list-style-type: none"> 1: The input voltage is too high. 2: An external force drives the motor during acceleration. 3: The acceleration time is too Short. 4: The braking unit and braking resistor are not installed. 	<ol style="list-style-type: none"> 1: Adjust the voltage to normal range. 2: Cancel the external force or install a braking resistor. 3: Increase the acceleration time. 4: Install the braking unit and braking resistor.
Overvoltage during deceleration	OU2	<ol style="list-style-type: none"> 1: The input voltage is too high. 2: An external force drives the motor during deceleration. 3: The deceleration time is too Short. 4: The braking unit and braking resistor are not installed. 	<ol style="list-style-type: none"> 1: Adjust the voltage to normal range. 2: Cancel the external force or install the braking resistor. 4: Install the braking unit and braking resistor.
Overvoltage at constant speed	OU3	<ol style="list-style-type: none"> 1: The input voltage is too high. 2: An external force drives the motor during deceleration. 	<ol style="list-style-type: none"> 1: Adjust the voltage to normal range. 2: Cancel the external force or install the braking resistor.
Control power supply fault	POFF	The input voltage is not within the allowable range.	Adjust the input voltage to the allowable range.
Lack of voltage	LU	<ol style="list-style-type: none"> 1: Instantaneous power failure occurs on the input power supply. 2: The AC drive's input voltage is not within the allowable range. 3: The bus voltage is abnormal. 4: The rectifier bridge and buffer resistor are abnormal. 5: The drive board is abnormal. 6: The main control board is abnormal. 	<ol style="list-style-type: none"> 1: Reset the fault. 2: Adjust the voltage to normal range. 3, 4, 5, 6: Looking for technical support

Chapter 5 Fault checking and ruled out

Fault Name	Display of Panel	Possible Causes	Solutions
AC drive overload	OL2	<ol style="list-style-type: none"> 1: The load is too heavy or motor-stalled occurs on the motor. 2: The AC drive model is of too small power class. 	<ol style="list-style-type: none"> 1: Reduce the load and check the motor and mechanical condition. 2: Select an AC drive of higher power class
Motor overload	OL1	<ol style="list-style-type: none"> 1: P9.01 is set improperly. 2: The load is too heavy or motor-stalled occurs on the motor. 3: The AC drive model is of too small power class. 	<ol style="list-style-type: none"> 1: Set P9.01 correctly. 2: Reduce the load and check the motor and the mechanical condition. 3: Select an AC drive of higher power class.
Power output phase loss (reserved)	Lo	<ol style="list-style-type: none"> 1: The cable connecting the AC drive and the motor is faulty. 2: The AC drive's three-phase output is unbalanced when the motor is running. 3: The drive board is faulty. 4: The module is faulty. 	<ol style="list-style-type: none"> 1: Eliminate external faults. 2: Check whether the motor three-phase winding is normal. 3: Looking for technical support .
Module overheat	OH	<ol style="list-style-type: none"> 1: The ambient temperature is too temperature. 2: The air filter is blocked. 3: The fan is damaged. 4: The thermally sensitive resistor of the module is damaged. 5: The inverter module is damaged. 	<ol style="list-style-type: none"> 1: Lower the ambient High. 2: Clean the air filter. 3: Replace the damaged fan 4: Replace the damaged thermally sensitive resistor. 5: Replace the inverter module.
External equipment fault	EF	<ol style="list-style-type: none"> 1: External fault signal is input via X. 2: External fault signal is input via virtual I/O. 	Reset the operation.
Communication fault	CE	<ol style="list-style-type: none"> 1: The host computer is in abnormal state. 2: The communication cable is faulty. 3: P028 is set improperly. 4: The communication parameters in group PD are set improperly. 	<ol style="list-style-type: none"> 1: Check the cabling of host computer. 2: Check the communication cabling. 3: Set P028 correctly. 4: Set the communication parameters properly.

Operation Instruction of NZ2000 Series Inverter

Fault Name	Display of Panel	Possible Causes	Solutions
Contactor fault	rAy	1: The drive board and power supply are faulty. 2: The contactor is faulty.	1: Replace the faulty drive board or power supply board. 2: Replace the faulty Contactor.
Current detection fault	IE	1: The HALL device is faulty. 2: The drive board is faulty.	1: Replace the faulty HALL device. 2: Replace the faulty drive board.
Motor auto-tuning fault	TE	1: The motor parameters are not set according to the nameplate. 2: The motor auto-tuning times out.	1: Set the motor parameters according to the nameplate property. 2: Check the cable connecting the AC drive and the motor.
EEPROM read-write fault	EEP	The EEPROM chip is damaged.	Replace the main control board.
AC drive hardware fault	OUOC	1: Overvoltage exists. 2: Overcurrent exists.	1: Handle based on overvoltage. 2: Handle based on overcurrent.
Short circuit to ground fault	GND	The motor is short circuited to the ground.	Replace the cable or motor.
Accumulative running time reached	END1	The accumulative running time reaches the setting value.	Clear the record through The parameter initialization function.
Accumulative power-on time reached	END2	The accumulative power-on time reaches the setting value.	Clear the record through The parameter initialization function.
Load becoming 0	LOAD	The AC drive running current is lower than P9.64.	Check that the load is disconnected or the setting of P9.64 and P9.65 is correct.
PID feedback lost during running fault	PIDE	The PID feedback is lower than the setting of PA.26.	Check the PID feedback signal or set PA.26 to a proper value.

Chapter 5 Fault checking and ruled out

Fault Name	Display of Panel	Possible Causes	Solutions
Pulse-by-pulse current limit fault	CBC	1: The load is too heavy or locked-rotor occurs on the motor. 2: The AC drive model is of too small power class.	1: Reduce the load and check the motor and mechanical condition. 2: Select an AC drive of higher power class.
Too large speed deviation fault	ESP	1: The encoder parameters are set incorrectly. 2: The motor auto-tuning is not performed. 3: Parameters of too large speed deviation P9.69 and P9.70 are set incorrectly.	1: Set the encoder parameters properly. 2: Perform the motor auto-tuning. 3: Set P9.69 and P9.70 correctly based on the actual situation.
Motor over-speed fault	oSP	1: The encoder parameters are set incorrectly. 2: The motor auto-tuning is not performed. 3: Motor over-speed detection parameters P9.69 and P9.70 are set incorrectly.	1: Set the encoder parameters properly. 2: Perform the motor auto-tuning. 3: Set motor over-speed detection parameters correctly based on the actual situation.

5.2 Common Faults and Solutions

You may come across the following faults during the use of the AC drive. Refer to the following table for simple fault analysis.

Table 5-1 Troubleshooting to common faults of the AC drive

SN	Fault	Possible Causes	Solutions
1	There is no display when the power is on.	1: There is no power supply to the AC drive or the power input to the AC drive is too low. 2: The power supply of the switch on the drive board of the AC drive is faulty. 3: The rectifier bridge is damaged. 4: The control board or the operation panel is faulty. 5: The cable connecting the control board and the drive board and the operation panel breaks.	1: Check the power supply. 2: Check the bus voltage. 3: Looking for technical support

Operation Instruction of NZ2000 Series Inverter

SN	Fault	Possible Causes	Solutions
2	"2000" is displayed when the power is on.	<ol style="list-style-type: none"> 1: The cable between the drive board and the control board is in poor contact. 2: Related components on the control board are damaged. 3: The motor or the motor cable is short circuited to the ground. 4: The HALL device is faulty. 5: The power input to the AC drive is too low. 	Looking for technical support
3	"GND" is displayed when the power is on.	<ol style="list-style-type: none"> 1: The motor or the motor output cable is short-circuited to the ground. 2: The AC drive is damaged. 	<ol style="list-style-type: none"> 1: Measure the insulation of the motor and the output cable with a megger. 2: Looking for technical support
4	The AC drive display is normal when the power is on. But "2000" is displayed after running and stops immediately.	<ol style="list-style-type: none"> 1: The cooling fan is damaged or locked-rotor occurs. 2: The external control terminal cable is short circuited. 	<ol style="list-style-type: none"> 1: Replace the damaged fan. 2: Eliminate external faults.
5	OH (module overheat) fault is reported frequently.	<ol style="list-style-type: none"> 1: The setting of carrier frequency is too high. 2: The cooling fan is damaged, or the air filter is blocked. 3: Components inside the AC drive are damaged (thermal coupler or others). 	<ol style="list-style-type: none"> 1: Reduce the carrier frequency (P017). 2: Replace the fan and clean the air filter. 3: Looking for technical support
6	The motor does not rotate after the AC drive runs.	<ol style="list-style-type: none"> 1: Check the motor and the motor Cables. 2: The AC drive parameters are set improperly (motor parameters). 3: The cable between the drive board and the control board is in poor contact. 4: The drive board is faulty. 	<ol style="list-style-type: none"> 1: Ensure the cable between the AC drive and the motor is normal. 2: Replace the motor or clear mechanical faults. 3: Check and re-set motor parameters.

Chapter 5 Fault checking and ruled out

SN	Fault	Possible Causes	Solutions
7	The S terminals are disabled.	<ol style="list-style-type: none"> 1: The parameters are set incorrectly. 2: The external signal is incorrect 3: The jumper bar across OP and +24 V becomes loose. 4: The control board is faulty. 	<ol style="list-style-type: none"> 1: Check and reset the parameters in group P5. 2: Re-connect the external signal cables. 3: Re-confirm the jumper bar across OP and +24 V. 4: Looking for technical support
8	Reserved		
9	The AC drive reports overcurrent and overvoltage frequently.	<ol style="list-style-type: none"> 1: The motor parameters are set improperly. 2: The acceleration/deceleration time is improper. 3: The load fluctuates. 	<ol style="list-style-type: none"> 1: Re-set motor parameters or re-perform the motor auto-tuning. 2: Set proper acceleration/deceleration time. 3: Looking for technical support
10	RAY is reported when the power is or the AC drive is running.	The soft startup contactor is not picked up.	<ol style="list-style-type: none"> 1: Check whether the contactor cable is loose. 2: Check whether the contactor is faulty. 3: Check whether 24 V power supply of the contactor is faulty. 4: Looking for technical support

Chapter 6 Maintenance

 WARNING
<ul style="list-style-type: none"> ● Maintenance must be performed according to designated maintenance methods. ● Maintenance, inspection and replacement of parts must be performed only by certified person. ● After turning off the main circuit power supply, wait for 10 minutes before maintenance or inspection. ● DO NOT directly touch components or devices of PCB board. Otherwise inverter can be damaged by electrostatic. ● After maintenance, all screws must be tightened.

6.1 Inspection

In order to prevent the fault of inverter to make it operate smoothly in high-performance for a long time, user must inspect the inverter periodically (within half year). The following table indicates the inspection content.

Items to be checked	contents
Temperature/humidity	ambient temperature shall be lower than 40℃ Humidity shall meet the requirement of 20~90% and has no Gel
Smoke and dust	No dust accumulation, no traces of water leakage and no condensate.
Inverter	Check the inverter to ensure it has no abnormal heat. abnormal vibration
fan	Ensure the fan operation is normal, no debris stuck, etc.
power input	power input voltage and frequency are at the permissible range
Motor	To check the motor whether the motor has abnormal vibration ; abnormal heat; abnormal noise and phase loss, etc

6.2 Periodic Maintenance

Customers should check the drive in a regular time to make it operate smoothly in high-performance for a long time. the checking

contents are as follows:

Items to be checked	checking contents	Solutions
the screws of control terminals	whether the screws of control terminals are loose	tighten them
PCB	Duct and dirt	Clean the dust on PCBs and air ducts with a vacuum cleaner
Fan	abnormal noise, abnormal vibration, whether it has used up 20,000 hours	Clear debris and replace the fan
Electrolytic capacitor	Whether the color is changed and the smell is abnormal	Change the electrolytic capacitor
Heatsink	Duct and dirt	Clean the dust and air ducts with a vacuum cleaner
Power Components	Duct and dirt	Clean the dust and air ducts with a vacuum cleaner

6.3 Replacement of wearing parts

Fans and electrolytic capacitors are wearing part, please make periodic replacement to ensure long term, safety and failure-free operation. The replacement periods are as follows:

- ◆ Fan: Must be replaced when using up to 20,000 hours;
- ◆ Electrolytic Capacitor: Must be replaced when using up to 30,000~40,000 hours.

6.4 Inverter Warranty

The company provides 12 months of warranty for NZ2000 Inverter since it go out from the factory.

Chapter 7 Peripheral Devices Selection

Check the motor capacity of the inverter you purchased. Appropriate peripheral devices must be selected according to the capacity. Refer to the following list and prepare appropriate peripheral devices:

7.1 Peripheral Devices Description

Devices Name	Description
Circuit breaker and leakage breaker.	Protect inverter wiring, convenient to the installation and maintenance.
Electromagnetic contactor	Inverter is convenient to the power supply's power-on and power-off ,ensure the safety
Surge absorber	
Isolation Transformers	Isolation to the Inverter's input and output, Reduce interference
DC Reactor	Protect the Inverter and suppress higher harmonics.
AC Reactor	Protect the Inverter and suppress higher harmonics. Prevent the impact of surge voltage
Brake resistor and brake unit	Absorb the renewable Energy
Noise filter	To reduce the electromagnetic disturbance which is generated by inverter.
Ferrite ring	To reduce the electromagnetic disturbance which is generated by inverter.

7.2 Applied Braking resistor Specification

Model	Brake resistor		Brake Unit CDBR	Motor Output (kW)
	Power (W)	Resistance Value(Ω) (\pm)		
NZ2200-0R4G	80W	200	embedded	0.4
NZ2200-0R75G	80W	150		0.75
NZ2200-1R5G	100W	100		1.5
NZ2200-2R2G	100W	70		2.2
NZ2200-3R7G	250W	65		3.7
NZ2200-5R5G	550W	35		5.5
NZ2200-7R5G	780W	26		7.5
NZ2400-0R4G	150W	300		0.4
NZ2400-0R75G	150W	300		0.75
NZ2400-1R5G	150W	220		1.5
NZ2400-2R2G	250W	200		2.2
NZ2400-3R7G/5R5P	300W	130		3.7/5.5
NZ2400-5R5G	400W	90		5.5
NZ2400-7R5P	500W	65		7.5
NZ2400-7R5G/11P	500W	65		7.5/11
NZ2400-11G/15P	800W	43		11/15
NZ2400-15G/18.5P	1000W	32		15/18.5
NZ2400-18.5G/22P	4kW	24		18.5/22
NZ2400-22G/30P	4.5kW	24		22/30
NZ2400-30G/37P	6kW	19.2		30/37
NZ2400-37G/45P	7kW	14.8	37/45	

Operation Instruction of NZ2000 Series Inverter

Model	Brake resistor		Brake Unit CDBR	Motor Output (kW)
	Power (W)	Resistance Value(Ω) (≥)		
NZ2400-45G/55P	9kW	12.8	optional (embedded)	45/55
NZ2400-55G	11kW	9.6		55
NZ2400-75P	11kW	9.6		75
NZ2400-75G/90P	15kW	6.8		75/90
NZ2400-90G/110P	9kW*2	9.3*2		90/110
NZ2400-110G/132P	11kW*2	9.3*2		110/132
NZ2400-132G/160P	13kW*2	6.2*2		132/160
NZ2400-160G/185P	16kW*2	6.2*2		160/185
NZ2400-185G/200P	19kW*2	2.5*2	external	185/200
NZ2400-200G/220P	19kW*2	2.5*2		200/220
NZ2400-220G/250P	21kW*2	2.5*2		220/250
NZ2400-250G/280P	24kW*2	2.5*2		250/280
NZ2400-280G/315P	27kW*2	2.5*2		280/315
NZ2400-315G/350P	20kW*3	2.5*3		315/350
NZ2400-350G/400P	23kW*3	2.5*3		350/400
NZ2400-400G/450P	26kW*3	2.5*3		400/450
NZ2400-450G/500P	29kW*3	2.5*3	450/500	

Calculate of Braking resistor value:

The Braking resistor value is related to the DC currency when the inverter braking. For 380V power supply, the braking DC voltage is 800V-820V, and for 220V system, the DC voltage is 400V.

Moreover, the Braking resistor value is related to braking torque Mbr%, and to the different braking torque the Braking resistor values are different, and the calculation formula is as follow:

$$R = \frac{U_{dc}^2 \times 100}{P_{Motor} \times M_{br}\% \times \eta_{transducer} \times \eta_{Motor}}$$

Among them,

U_{dc} —Braking DC voltage;

P_{Motor} —Motor power;

M_{br} —Braking torsion;

η_{Motor} —Motor efficiency;

$\eta_{Transducer}$ —Transducer efficiency.

The braking power is related to braking torque and braking frequency. the foregoing illustration gives the braking torque as 125% and the frequency is 10%, and according to the different loading situations, the numbers in the illustration are for reference.

Appendix A

List of Function Parameters

If PP.00 is set to a non-zero number, parameter protection is enabled. You must enter the correct user password to enter the menu. To cancel the password protection function, enter with password and set PP.00 to 0. Parameters menu the user customizes are not protected by password. Group P is the basic function parameters , Group D is to monitor the function parameters. The symbols in the function code table are described as follows:
 "☆": The parameter can be modified when the AC drive is in either stop or running state.
 "★": The parameter cannot be modified when the AC drive is in the running state.
 "●": The parameter is the actually measured value and cannot be modified.
 "M": The parameter is factory parameter and can be set only by the manufacturer.

Standard Function Parameters

Function Code	Parameter Name	Setting Range	Default	Property
Group P0: Standard Function Parameters				
P0.00	G/P type display	1: G type (constant torque load) 2: P type (variable torque load e.g. fan and pump)	Model dependent	☆
P0.01	Control mode selection	0: Voltage/Frequency (V/F) control 1: Sensorless flux vector control (SFVC)	0	★
P0.02	Command source selection	0: Operation panel control 1: Terminal control 2: Communication control	0	☆

Appendix A List of Function Parameters

Function Code	Parameter Name	Setting Range	Default	Property
P0.03	Frequency source superposition selection	Unit's digit (Frequency source) 0:Main frequency source X 1:X and Y operation(operation relationship determined by ten's digit) 2:Switchover between X and Y 3:Switchover between X and "X and Y operation" 4:Switchover between Y and "X and Y operation" Ten's digit (X and Y operation) 0:X+Y 1:X-Y 2:Maximum 3:Minimum	00	☆
P0.04	Main frequency source X selection	0:Digital setting (P01.0 preset frequency, can modify the UP/DOWN, power lost don't memory) 1:Digital setting (P0.10 preset frequency, can modify the UP/DOWN, power lost memory) 2:FIV 3:FIC 4:Reserved 5:Pulse setting(S3) 6:Multistage instruction 7:Simple PLC 8:PID 9:Communications given	0	★
P0.05	Auxiliary frequency source Y selection	The same as P0.04 (Main frequency source X selection)	0	★
P0.06	Auxiliary frequency source superposition Y range selection	0: Relative to the maximum frequency 1: Relative to the main frequency source X	0	☆
P0.07	Auxiliary frequency source superposition Y range	0%~150%	100%	☆

Operation Instruction of NZ2000 Series Inverter

Function Code	Parameter Name	Setting Range	Default	Property
P0.08	Acceleration time 1	0.00s~65000s	Model dependent	☆
P0.09	Deceleration time 1	0.00s~65000s	Model dependent	☆
P0.10	Frequency preset	0.00Hz~maximum frequency(P0.12)	50.00Hz	☆
P0.11	Rotation direction	0: Same direction 1: Reverse direction	0	☆
P0.12	Maximum frequency	50.00Hz~320.00Hz	50.00Hz	★
P0.13	Upper limit frequency source	0: P0.12 1: FIV 2: FIC 3: reserved 4: PULSE settings 5: communication settings	0	★
P0.14	Upper limit frequency	Frequency lower limit P0.16~Maximum frequency P0.12	50.00Hz	☆
P0.15	Upper limit frequency offset	0.00Hz~Maximum frequency P0.12	0.00Hz	☆
P0.16	Frequency lower limit	0.00Hz~Upper limit frequency P0.14	0.00Hz	☆
P0.17	Carrier frequency	1kHz~16.0kHz	Model dependent	☆
P0.18	Carrier frequency adjustment with temperature	0: No 1: Yes	1	☆
P0.19	Acceleration/Deceleration time unit	0: 1s 1: 0.1s 2: 0.01s	1	★
P0.21	Frequency offset of auxiliary frequency source for X and Y operation	0.00Hz~Maximum frequency P0.12	0.00Hz	☆
P0.22	Frequency reference	1:0.1Hz 2:0.01Hz	2	★

Appendix A List of Function Parameters

Function Code	Parameter Name	Setting Range	Default	Property
P0.23	Retentive of digital setting frequency upon power	0:Not retentive 1:Retentive	0	☆
P0.24	Acceleration/Deceleration time base frequency	0:Maximum frequency (P0.12) 1:Set frequency 2:100Hz	0	★
P0.25	Base frequency for UP/DOWN modification during running	0: Running frequency 1: Set frequency	0	★
P0.26	Binding command source to frequency source	Unit's digit:Binding operation panel command to frequency source 0:No binding 1:Frequency source by digital setting 2:FIV 3:FIC 4:Reserved 5:Pulse setting (S3) 6:Multi-reference 7:Simple PLC 8:PID 9:Communication setting Ten's digit:Binding terminal command to frequency source(0~9,same as unit's dglgt) Hundred's digit:Binding communication command to frequency source(0~9,same as unit's dglgt)	000	☆
P0.27	Communication expansion card type	0:Modbus communication card	0	☆
Group P1:Start/Stop Control				
P1.00	Start mode	0: direct start 1: Rotational speed tracking restart 2: Pre-excited start (asynchronous motor)	0	☆

Operation Instruction of NZ2000 Series Inverter

Function Code	Parameter Name	Setting Range	Default	Property
P1.01	Rotational speed tracking mode	0: From frequency at stop 1: From zero speed 2: From maximum frequency	0	★
P1.02	Rotational speed tracking speed	1~100	20	☆
P1.03	Startup frequency	0.00Hz~10.00Hz	0.00Hz	☆
P1.04	Startup frequency holding time	0.0s~100.0s	0.0s	★
P1.05	Startup DC braking current/ Pre-excited current	0%~100%	0%	★
P1.06	Startup DC braking time/ Pre-excited time	0.0s~100.0s	0.0s	★
P1.07	Acceleration/ Deceleration mode	0: Linear acceleration/ deceleration 1: S-curve acceleration/ deceleration A 2: S-curve acceleration/ deceleration B	0	★
P1.08	Time proportion of S-curve start	0.0%~ (100.0%-P1.09)	30.0%	★
P1.09	Time proportion of S-curve end	0.0%~ (100.0%-P1.08)	30.0%	★
P1.10	Stop mode	0: Decelerate to stop 1: Coast to stop	0	☆
P1.11	Initial frequency of stop DC braking	0.00Hz~maximum frequency	0.00Hz	☆
P1.12	Waiting time of stop DC braking	0.0s~100.0s	0.0s	☆
P1.13	Stop DC braking current	0%~100%	0%	☆
P1.14	Stop DC braking time	0.0s~100.0s	0.0s	☆
P1.15	Brake use ratio	0%~100%	100%	☆
Group P2: Motor Parameters				

Appendix A List of Function Parameters

Function Code	Parameter Name	Setting Range	Default	Property
P2.00	Motor type selection	0: Common asynchronous motor 1: Variable frequency asynchronous motor	0	★
P2.01	Rated motor power	0.1kW~30.0kW	Model dependent	★
P2.02	Rated motor voltage	1V~2000V	Model dependent	★
P2.03	Rated motor current	0.01A~655.35A	Model dependent	★
P2.04	Rated motor frequency	0.01Hz~maximum frequency	Model dependent	★
P2.05	Rated motor rotational speed	1rpm~65535rpm	Model dependent	★
P2.06	Stator resistance (asynchronous motor)	0.001Ω~65.535Ω	Model dependent	★
P2.07	Rotor resistance (asynchronous motor)	0.001Ω~65.535Ω	Model dependent	★
P2.08	Leakage inductive reactance (asynchronous)	0.01mH~655.35mH	Model dependent	★
P2.09	Mutual inductive reactance (asynchronous motor)	0.1mH~6553.5mH	Model dependent	★
P2.10	No-load current (synchronous motor)	0.01A~P2.03	Model dependent	★
P2.11-P2.36 Reserved				
P2.37	Auto-tuning selection	0:No auto-tuning 1:Asynchronous motor static auto-tuning 2:Asynchronous motor complete auto-tuning	0	★
Group P3: Vector Control Parameters				
P3.00	Speed loop proportional gain 1	1~100	30	☆

Operation Instruction of NZ2000 Series Inverter

Function Code	Parameter Name	Setting Range	Default	Property
P3.01	Speed loop integral time 1	0.01s~10.00s	0.50s	☆
P3.02	Switchover frequency 1	0.00~P3.05	5.00Hz	☆
P3.03	Speed loop proportional gain 2	1~100	20	☆
P3.04	Speed loop integral time 2	0.01s~10.00s	1.00s	☆
P3.05	Switchover frequency 2	P3.02~maximum output frequency	10.00Hz	☆
P3.06	Vector control slip gain	50%~200%	100%	☆
P3.07	Time constant of speed loop filter	0.000s~0.100s	0.000s	☆
P3.08	Vector control over-excitation gain	0~200	64	☆
P3.09	Torque upper limit source in speed control mode	0:P3.10 1:FIV 2:FIC 3:Reserved 4:Pulse setting 5:Communication setting 6:MIN(FIV,FIC) 7:MAX(FIV,FIC)	0	☆
P3.10	digital setting of torque upper limit in speed control mode	0.0%~200.0%	150.0%	☆
P3.13	Excitation adjustment proportional gain	0~60000	2000	☆
P3.14	Excitation adjustment integral gain	0~60000	1300	☆
P3.15	Torque adjustment proportional gain	0~60000	2000	☆
P3.16	Torque adjustment integral gain	0~60000	1300	☆

Appendix A List of Function Parameters

Function Code	Parameter Name	Setting Range	Default	Property
P3.17	Speed loop integral property	Unit's digit: integral separation 0: Disabled 1: Enabled	0	☆
P3.18 Reserved				
P3.19 Reserved				
P3.20 Reserved				
P3.21 Reserved				
P3.22 Reserved				
Group P4: V/F Control Parameters				
P4.00	V/F curve setting	0:Linear V/F 1:Multi-point V/F 2:Square V/F 3:1.2-power V/F 4:1.4-power V/F 6:1.6-power V/F 8:1.8-power V/F 9:Reserved 10:V/F complete separation 11:V/F half separation	0	★
P4.01	Torque boost	0.0%: (Automatic torque boost) 0.1%~30.0%	Model dependent	☆
P4.02	Cut-off frequency of torque boost	0.00Hz~maximum output frequency	50.00Hz	★
P4.03	Multi-point V/F frequency 1 (F1)	0.00Hz~P4.05	0.00Hz	★
P4.04	Multi-point V/F voltage 1 (V1)	0.0%~100.0%	0.0%	★
P4.05	Multi-point V/F frequency 2 (F2)	P4.03~P4.07	0.00Hz	★
P4.06	Multi-point V/F voltage 2 (V2)	0.0%~100.0%	0.0%	★
P4.07	Multi-point V/F frequency 3 (F3)	P4.05~rated motor frequency (P1.04)	0.00Hz	★
P4.08	Multi-point V/F voltage 3 (V3)	0.0%~100.0%	0.0%	★
P4.09	V/F slip compensation gain	0.0%~200.0%	0.0%	☆
P4.10	V/F over-excitation gain	0~200	64	☆

Operation Instruction of NZ2000 Series Inverter

Function Code	Parameter Name	Setting Range	Default	Property
P4.11	V/F oscillation suppression gain	0~100	Model dependent	☆
P4.13	Voltage source for V/F separation	0:digital setting(P4.14) 1:FIV 2:FIC 3:Reserved 4:PULSE setting(S3) 5:Multi-reference 6:Simple PLC 7:PID 8:Communication setting 100.0% corresponds to the rated motor voltage.	0	☆
P4.14	Voltage digital setting for V/F separation	0V~rated motor voltage	0V	☆
P4.15	Voltage rise time of V/F separation	0.0s~1000.0s It indicates the time for the voltage rising from 0 V to rated motor voltage.	0.0s	☆
P4.16	Voltage decline time of V/F separation	0.0s~1000.0s It indicates the time for the voltage to decline from rated motor voltage to 0 V.	0.0s	☆
Group P5: Input Terminals				

Appendix A List of Function Parameters

Function Code	Parameter Name	Setting Range	Default	Property
P5.00	FWD function selection	0:No function 1:Forward RUN(FWD)	1	★
P5.01	REV function selection	2:Reverse RUN(REV) 3:Three-line control	4	★
P5.02	S1 function selection	4:Forward JOG(FJOG) 5:Reverse JOG(RJOG)	9	★
P5.03	S2 function selection	6:Terminal UP 7:Terminal DOWN 8:Coast to stop 9:Fault reset(RESET) 10:RUN pause 11:Normally open (NO) input of external fault 12:Multi-reference terminal 1 13:Multi-reference terminal 2 14:Multi-reference terminal 3 15:Multi-reference terminal 4 16:Terminal 1 for acceleration/ deceleration time selection 17:Terminal 2 for acceleration/ deceleration time selection 18:Frequency source Switchover 19:UP and DOWN setting clear (terminal, operation panel) 20:Command source switchover terminal 21:Acceleration/Deceleration Prohibited 22:PID pause 23:PLC status reset 24:Swing pause 25:Counter input 26:Counter reset 27:Length count input 28:Length reset 29:Torque control prohibited 30:Pulse input (enabled only for S3) 31:Reserved 32:Immediate DC braking 33:Normally closed (NC) input of external fault	12	★

Operation Instruction of NZ2000 Series Inverter

Function Code	Parameter Name	Setting Range	Default	Property
P5.04	S3 function selection	34:Frequency modification forbidden	13	★
P5.05	S4 function selection	35:Reverse PID action direction 36:External STOP terminal 1 37:Command source switchover terminal 2 38:PID integral pause 39:Switchover between main frequency source X and preset frequency 40:Switchover between auxiliary frequency source Y and preset frequency 41:Motor selection terminal 1 42:Motor selection terminal 2 43:PID parameter switchover 44:Reserved 45:Reserved 46:Speed control/Torque control switchover 47:Emergency stop 48:External STOP terminal 2 49:Deceleration DC braking 50:Clear the current running time 51-59:Reserved	0	★
P5.10	S filter time	0.000s~1.000s	0.010s	☆
P5.11	Terminal command mode	0: Two-line mode 1 1: Two-line mode 2 2: Three-line mode 1 3: Three-line mode 2	0	★
P5.12	Terminal UP/DOWN rate	0.001Hz/s~65.535Hz/s	1.00Hz/s	☆
P5.13	FI curve 1 minimum input	0.00V~P5.15	0.00V	☆
P5.14	Corresponding setting of FI curve 1 minimum input	-100.0%~+100.0%	0.0%	☆
P5.15	FI curve 1 maximum input	P5.13~+10.00V	10.00V	☆
P5.16	Corresponding setting of FI curve 1 maximum input	-100.0%~+100.0%	100.0%	☆

Appendix A List of Function Parameters

Function Code	Parameter Name	Setting Range	Default	Property
P5.17	FI curve 1 filter time	0.00s~10.00s	0.10s	☆
P5.18	FI curve 2 minimum input	0.00V~P5.20	0.00V	☆
P5.19	Corresponding setting of FI curve 2 minimum input	-100.0%~+100.0%	0.0%	☆
P5.20	FI curve 2 maximum input	P5.18~+10.00V	10.00V	☆
P5.21	Corresponding setting of FI curve 2 maximum input	-100.0%~+100.0%	100.0%	☆
P5.22	FI curve 2 filter time	0.00s~10.00s	0.10s	☆
P5.23	FI curve 3 minimum input	-10.00V~P5.25	-10.00V	☆
P5.24	Corresponding setting of FI curve 3 minimum input	-100.0%~+100.0%	-100.0%	☆
P5.25	FI curve 3 maximum input	P5.23~+10.00V	10.00V	☆
P5.26	Corresponding setting of FI curve 3 maximum input	-100.0%~+100.0%	100.0%	☆
P5.27	FI curve 3 filter time	0.00s~10.00s	0.10s	☆
P5.28	PULSE minimum input	0.00kHz~P5.30	0.00kHz	☆
P5.29	Corresponding setting of pulse minimum input	-100.0%~100.0%	0.0%	☆
P5.30	PULSE maximum input	P5.28~100.00kHz	50.00kHz	☆
P5.31	Corresponding setting of pulse maximum input	-100.0%~100.0%	100.0%	☆
P5.32	PULSE filter time	0.00s~10.00s	0.10s	☆

Operation Instruction of NZ2000 Series Inverter

Function Code	Parameter Name	Setting Range	Default	Property
P5.33	FI curve selection	Unit's digit: FIV curve selection 1: Curve 1(2 points, see P5.13~P5.16) 2: Curve 2(2 points, see P5.18~P5.21) 3: Curve 3(2 points, see P5.23~P5.26) 4: Curve 4(4 points, see C6.00~C6.07) 5: Curve 5(4 points, see C6.08~C6.15) Ten's digit: FIC curve selection(1~5, same as FIV) Hundred's digit: FIA curve selection(1~5, same as FIV)	321	☆
P5.34	Setting for FI less than minimum input	Unit's digit: Setting for FIV less than minimum input 0: Minimum value 1: 0.0% Ten's digit: Setting for FIC less than minimum input(0~1, same as FIV) Hundred's digit: Setting for FIA less than minimum input(0~1, same as FIV)	000	☆
P5.35	FWD delay time	0.0s~3600.0s	0.0s	★
P5.36	REV delay time	0.0s~3600.0s	0.0s	★
P5.37	S1 delay time	0.0s~3600.0s	0.0s	★
P5.38	S valid mode selection 1	0: High level valid 1: Low level valid Unit's digit: FWD Ten's digit: REV Hundred's digit: S1 Thousand's digit: S2 Ten thousand's digit: S3	00000	★
P5.39	S valid mode selection 2	0: High level valid 1: Low level valid Unit's digit: S4	0	★
Group P6: Output Terminals				
P6.00	M01 terminal output mode	1: Switch signal output(M01)	0	☆

Appendix A List of Function Parameters

Function Code	Parameter Name	Setting Range	Default	Property
P6.01	M01 function	0:No output 1:AC drive running 2:Fault output (stop) 3:Frequency-level detection FDT1 output 4:Frequency reached 5:Zero-speed running(no output at stop) 6:Motor overload pre-warning 7:AC drive overload pre- warning 8:Set count value Reached 9:Designated count value reached 10:Length reached 11:PLC cycle complete 12:Accumulative running time reached 13:Frequency limited 14:Torque limited 15:Ready for RUN 16:FIV>FIC 17:Frequency upper limit reached 18:Frequency lower limit reached (no output at stop) 19:Under voltage state output 20:Communication setting 21:Reserved 22:Reserved 23:Zero-speed running 2 (having output at stop) 24:Accumulative power-on time reached 25:Frequency level detection FDT2 output 26:Frequency 1 reached 27:Frequency 2 reached 28:Current 1 reached 29:Current 2 reached 30:Timing reached 31:FIV input limit exceeded 32:Load becoming 0 33:Reverse running 34:Zero current state 35:Module temperature reached 36:Software current limit exceeded	0	☆

Operation Instruction of NZ2000 Series Inverter

Function Code	Parameter Name	Setting Range	Default	Property
P6.02	Relay output function(RA-RB-RC)	37:Frequency lower limit reached (having output at stop) 38:Alarm output 39:Reserved 40:Current running time reached	2	☆
P6.07	FOV function selection	0:Running frequency 1:Set frequency 2:Output current 3:Output torque 4:Output power 5:Output voltage 6:Pulse input(100.0% for 100.0kHz)	0	☆
P6.08	Reserved	7:FIV 8:FIC 9:Reserved 10:Length 11:Count value 12:Communication setting 13:Motor rotational speed 14:Output current(100.0% for 1000.0A) 15:Output voltage(100.0% for 1000.0V) 16:Reserved		
P6.09	Reserved			☆
P6.10	FOV offset coefficient	-100.0%~+100.0%	0.0%	☆
P6.11	FOV gain	-10.00~+10.00	1.00	☆
P6.12	Reserved			☆
P6.13	Reserved			☆
P6.17	M01 output delay time	0.0s~3600.0s	0.0s	☆
P6.18	RA-RB-RC output delay time	0.0s~3600.0s	0.0s	☆
P6.19	reserved		0.0s	☆
P6.20	reserved			
P6.21	reserved			
P6.22	Output terminal valid mode selection	0:Positive logic 1:Negative logic Unit's digit:M01 Ten's digit:RA-RB-RC	00	☆

Appendix A List of Function Parameters

Function Code	Parameter Name	Setting Range	Default	Property
Group P7: Operation Panel and Display				
P7.00	Output power correction factor	0.0-200.0	100.0	☆
P7.01	Reserved			
P7.02	STOP/RESET key function	0:STOP/RESET key enabled only in operation panel control 1:STOP/RESET key enabled in any operation mode	1	☆
P7.03	LED display running parameters 1	0000-FFFF Bit00: Running frequency 1 (Hz) Bit01: Set frequency (Hz) Bit02: Bus voltage (V) Bit03: Output voltage (V) Bit04: Output current (A) Bit05: Output power (kW) Bit06: Output torque (%) Bit07: S input status Bit08: M01 output status Bit09: FIV voltage (V) Bit10: FIC voltage (V) Bit11: Reserved Bit12: Count value Bit13: Length value Bit14: Load speed display Bit15: PID setting	1F	☆

Operation Instruction of NZ2000 Series Inverter

Function Code	Parameter Name	Setting Range	Default	Property
P7.04	LED display running parameters 2	0000~FFFF Bit00: PID feedback Bit01: PLC stage Bit02: Pulse setting frequency(kHz) Bit03: Running frequency 2 (Hz) Bit04: Remaining running time Bit05: FIV voltage before correction (V) Bit06: FIC voltage before correction (V) Bit07: Reserved Bit08: Linear speed Bit09: Current power-on time(Hour) Bit10: Current running time (Min) Bit11: Pulse setting frequency(Hz) Bit12: Communication setting value Bit13: Reserved Bit14: Main frequency X display(Hz) Bit15:Auxiliary frequency Y display (Hz)	0	☆
P7.05	LED display stop parameters	0000~FFFF Bit00: Set frequency (Hz) Bit01: Bus voltage (V) Bit02: S input status Bit03: M01 output status Bit04: FIV voltage (V) Bit05: FIC voltage (V) Bit06: Reserved Bit07: Count value Bit08: Length value Bit09: PLC stage Bit10: Load speed Bit11: PID setting Bit12: Pulse setting frequency(kHz) Bit13: PID feedback value	33	☆
P7.06	Load speed display coefficient	0.0001~6.5000	1.0000	☆

Appendix A List of Function Parameters

Function Code	Parameter Name	Setting Range	Default	Property
P7.07	Heatsink temperature of inverter	0.0°C~150.0°C	-	●
P7.08	Temporary software version	0.0°C~150.0°C	-	●
P7.09	Accumulative running time	0h~65535h	-	●
P7.10	reserved	-	-	●
P7.11	Software version	-	-	●
P7.12	Numbers of decimal places for load speed display	0: 0 decimal place 1: 1 decimal place 2: 2 decimal places 3: 3 decimal places	1	☆
P7.13	Accumulative power-on time	0h~65535h	-	●
P7.14	Accumulative power consumption	0kW~65535kWh	-	●
Group P8: Auxiliary Functions				
P8.00	JOG running frequency	0.00Hz~maximum frequency	2.00Hz	☆
P8.01	JOG acceleration time	0.0s~6500.0s	20.0s	☆
P8.02	JOG deceleration time	0.0s~6500.0s	20.0s	☆
P8.03	Acceleration time 2	0.0s~6500.0s	Model dependent	☆
P8.04	Deceleration time 2	0.0s~6500.0s	Model dependent	☆
P8.05	Acceleration time 3	0.0s~6500.0s	Model dependent	☆
P8.06	Deceleration time 3	0.0s~6500.0s	Model dependent	☆
P8.07	Acceleration time 4	0.0s~6500.0s	Model dependent	☆
P8.08	Deceleration time 4	0.0s~6500.0s	Model dependent	☆
P8.09	Jump frequency 1	0.00Hz~maximum frequency	0.00Hz	☆

Operation Instruction of NZ2000 Series Inverter

Function Code	Parameter Name	Setting Range	Default	Property
P8.10	Jump frequency 2	0.00Hz~maximum frequency	0.00Hz	☆
P8.11	Frequency jump amplitude	0.00Hz~maximum frequency	0.01Hz	☆
P8.12	Forward/ Reverse rotation dead-zone time	0.0s~3000.0s	0.0s	☆
P8.13	Reverse control	0: Enabled 1: Disabled	0	☆
P8.14	Running mode when set frequency lower than frequency lower limit	0: Run at frequency lower limit 1: Stop 2: Run at zero speed	0	☆
P8.15	Droop control	0.00Hz~10.00Hz	0.00Hz	☆
P8.16	Accumulative power-on time threshold	0h~65000h	0h	☆
P8.17	Accumulative running time threshold	0h~65000h	0h	☆
P8.18	Startup protection	0: No 1: Yes	0	☆
P8.19	Frequency detection value(FDT1)	0.00Hz~maximum frequency	50.00Hz	☆
P8.20	Frequency detection hysteresis(FDT1)	0.0%~100.0% (FDT1 level)	5.0%	☆
P8.21	Detection range of frequency reached	0.0%~100.0% (maximum frequency)	0.0%	☆
P8.22	Jump frequency during acceleration/ deceleration	0: Disabled 1: Enabled	0	☆
P8.25	Frequency switchover point between acceleration time 1 and acceleration time 2	0.00Hz~maximum frequency	0.00Hz	☆

Appendix A List of Function Parameters

Function Code	Parameter Name	Setting Range	Default	Property
P8.26	Frequency switchover point between deceleration time 1 and deceleration time 2	0.00Hz~maximum frequency	0.00Hz	☆
P8.27	Terminal JOG preferred	0: Disabled 1: Enabled	0	☆
P8.28	Frequency detection value (FDT2)	0.00Hz~maximum frequency	50.00Hz	☆
P8.29	Frequency detection hysteresis (FDT2)	0.0%~100.0% (FDT2 level)	5.0%	☆
P8.30	Any frequency reaching detection value 1	0.00Hz~maximum frequency	50.00Hz	☆
P8.31	Any frequency reaching detection amplitude 1	0.0%~100.0% (maximum frequency)	0.0%	☆
P8.32	Any frequency reaching detection value 2	0.00Hz~maximum frequency	50.00Hz	☆
P8.33	Any frequency reaching detection amplitude 2	0.0%~100.0% (maximum frequency)	0.0%	☆
P8.34	Zero current detection level	0.0%~300.0% 100.0% for rated motor current	5.0%	☆
P8.35	Zero current detection delay time	0.01s~600.00s	0.10s	☆
P8.36	Output over current threshold	0.0% (no detection) 0.1%~300.0% (rated motor current)	200.0%	☆
P8.37	Output over current detection delay time	0.00s~600.00s	0.00s	☆

Operation Instruction of NZ2000 Series Inverter

Function Code	Parameter Name	Setting Range	Default	Property
P8.38	Any current reaching 1	0.0%~300.0% (rated motor current)	100.0%	☆
P8.39	Any current reaching 1 amplitude	0.0%~300.0% (rated motor current)	0.0%	☆
P8.40	Any current reaching 2	0.0%~300.0% (rated motor current)	100.0%	☆
P8.41	Any current reaching 2 amplitude	0.0%~300.0% (rated motor current)	0.0%	☆
P8.42	Timing function	0:Disabled 1:Enabled	0	☆
P8.43	Timing duration source	0: P8.44 1: FIV 2: FIC 3: reserved 100% of analog input corresponds to the value of P8.44	0	☆
P8.44	Timing duration	0.0Min~6500.0Min	0.0Min	☆
P8.45	FIV input voltage lower limit	0.00V~P8.46	3.10V	☆
P8.46	FIV input voltage upper limit	P8.45~10.00V	6.80V	☆
P8.47	Module temperature threshold	0°C~150°C	100°C	☆
P8.48	Cooling fan control	0: Fan working during running 1: Fan working continuously	0	☆
P8.49	Wakeup frequency	Dormant frequency (P8.51) ~maximum frequency (P0.12)	0.00Hz	☆
P8.50	Wakeup delay time	0.0s~6500.0s	0.0s	☆
P8.51	Dormant frequency	0.00Hz~wakeup frequency (P8.49)	0.00Hz	☆
P8.52	Dormant delay time	0.0s~6500.0s	0.0s	☆
P8.53	Current running time reached	0.0Min~6500.0Min	0.0Min	★

Appendix A List of Function Parameters

Function Code	Parameter Name	Setting Range	Default	Property
Group P9: Fault and Protection				
P9.00	Motor overload protection selection	0: Disabled 1: Enabled	1	☆
P9.01	Motor overload protection gain	0.20~10.00	1.00	☆
P9.02	Motor overload warning coefficient	50%~100%	80%	☆
P9.03	Overvoltage stall gain	0~100	0	☆
P9.04	Overvoltage stall protective voltage	120%~150%	130%	☆
P9.05	Over current stall gain	0~100	20	☆
P9.06	Over current stall protective current	100%~200%	150%	☆
P9.07	Short-circuit to ground upon power-on	0: Disabled 1: Enabled	1	☆
P9.09	Fault auto reset times	0~20	0	☆
P9.10	M01 action during fault auto reset	0: Not act 1: Act	0	☆
P9.11	Time interval of fault auto reset	0.1s~100.0s	1.0s	☆
P9.12	Reserved			☆
P9.13	Output phase loss protection selection	0: Disabled 1: Enabled	1	☆

Operation Instruction of NZ2000 Series Inverter

Function Code	Parameter Name	Setting Range	Default	Property
P9.14	1st fault type	0: No fault	-	●
P9.15	2nd fault type	1: Inverter unit protection 2: Overcurrent during acceleration 3: Overcurrent during deceleration 4: Overcurrent at constant speed 5: Overvoltage during acceleration 6: Overvoltage during deceleration 7: Overvoltage at constant speed 8: Buffer resistance overload 9: Undervoltage 10: AC drive overload 11: Motor overload 12: Reserved 13: Power output phase loss 14: Module overheat 15: External equipment fault 16: Communication fault 17: Contactor fault 18: Current detection fault 19: Motor auto-tuning fault 20: Reserved 21: EEPROM read-write fault 22: AC drive hardware fault 23: Short circuit to ground 24: Reserved 25: Reserved 26: Accumulative running time reached 27: Reserved 28: Reserved 29: Accumulative power-on time reached 30: Load becoming 0 31: PID feedback lost during running 40: With-wave current limit fault 41-43: Reserved 51: Reserved	-	●
P9.16	3rd (latest) fault type		-	●
P9.17	Frequency upon 3rd fault	-	-	●

Appendix A List of Function Parameters

Function Code	Parameter Name	Setting Range	Default	Property
P9.18	Current upon 3rd fault	-	-	●
P9.19	Bus voltage upon 3rd fault	-	-	●
P9.20	Input terminal status upon 3rd fault	-	-	●
P9.21	Output terminal status upon 3rd fault	-	-	●
P9.22	AC drive status upon 3rd fault	-	-	●
P9.23	Power-on time upon 3rd fault	-	-	●
P9.24	Running time upon 3rd fault	-	-	●
P9.27	Frequency upon 2nd fault	-	-	●
P9.28	Current upon 2nd fault	-	-	●
P9.29	Bus voltage upon 2nd fault	-	-	●
P9.30	Input terminal status upon 2nd fault	-	-	●
P9.31	Output terminal status upon 2nd fault	-	-	●
P9.32	Frequency upon 2nd fault	-	-	●
P9.33	Current upon 2nd fault	-	-	●
P9.34	Bus voltage upon 2nd fault	-	-	●
P9.37	Input terminal status upon 1st fault	-	-	●
P9.38	Output terminal status upon 1st fault	-	-	●
P9.39	Frequency upon 1st fault	-	-	●
P9.40	Current upon 1st fault	-	-	●

Operation Instruction of NZ2000 Series Inverter

Function Code	Parameter Name	Setting Range	Default	Property
P9.41	Bus voltage upon 3rd fault	-	-	●
P9.42	Output terminal status upon 1st fault	-	-	●
P9.43	Output terminal status upon 1st fault	-	-	●
P9.44	Frequency upon 1st fault	-	-	●
P9.47	Fault protection action selection 1	Unit's digit: Motor overload(OL1) 0: Coast to stop 1: Stop according to the stop mode 2: Continue to run Ten's digit: Reserved Hundred's digit: Power output phase loss(LO) Thousand's digit: External equipment fault(EF) Ten thousand's digit: Communication fault(CE)	00000	☆
P9.48	Fault protection action selection 2	Unit's digit: Reserved 0: Coast to stop Ten's digit: EEPROM read-write fault(EEP) 0: Coast to stop 1: Stop according to the stop mode Hundred's digit: Reserved Thousand's digit: Reserved Ten thousand's digit: Accumulative running time reached(END1)	00000	☆

Appendix A List of Function Parameters

Function Code	Parameter Name	Setting Range	Default	Property
P9.49	Fault protection action selection 3	Unit's digit: reserved Unit's digit:Reserved 0:Coast to stop 1:Stop according to the stop mode 2:Continue to run Ten's digit:Reserved 0:Coast to stop 1:Stop according to the stop mode 2:Continue to run Hundred's digit:Accumulative power-on time reached(END2) 0:Coast to stop 1:Stop according to the stop mode 2:Continue to run Thousand's digit:Load becoming 0 0:Coast to stop 1:Stop according to the stop mode 2:Continue to run at 7% of rated motor frequency and resume to the set frequency if the load recovers Ten thousand's digit: PID feedback loss of running 0:Coast to stop 1:Stop according to the stop mode 2:Continue to run	00000	☆
P9.50	Reserved			☆
P9.54	Frequency selection for continuing to run	0:Current running frequency 1:Set frequency 2:Frequency upper limit 3:Frequency lower limit 4:Backup frequency upon abnormality	0	☆
P9.55	Backup frequency upon abnormality	60.0%~100.0%	100.0%	☆
P9.56	reserved			☆
P9.57	reserved			☆
P9.58	reserved			☆

Operation Instruction of NZ2000 Series Inverter

Function Code	Parameter Name	Setting Range	Default	Property
P9.59	Action selection at instantaneous power failure	0: Invalid 1: Decelerate 2: Decelerate to stop	0	☆
P9.60	Action pause judging voltage at instantaneous power failure	0.0%~100.0%	100.0%	☆
P9.61	Voltage rally judging time at instantaneous power failure	0.00s~100.00s	0.50s	☆
P9.62	Action judging voltage at instantaneous power failure	60.0%~100.0% (standard bus voltage)	80.0%	☆
P9.63	Protection upon load becoming 0	0: Disabled 1: Enabled	0	☆
P9.64	Detection level of load becoming 0	0.0~100.0%	10.0%	☆
P9.65	Detection time of load becoming 0	0.0~60.0s	1.0s	☆
P9.67	Reserved			☆
P9.68	Reserved			☆
P9.69	Reserved			☆
P9.70	Reserved			☆
Group PA: Process Control PID Function				
PA.00	PID setting source	0:PA.01 1:FIV 2:FIC 3:Reserved 4:PULSE setting(S3) 5:Communication setting 6:Multi-reference	0	☆
PA.01	PID digital setting	0.0%~100.0%	50.0%	☆

Appendix A List of Function Parameters

Function Code	Parameter Name	Setting Range	Default	Property
PA.02	PID feedback source	0:FIV 1:FIC 2:Reserved 3:FIV-FIC 4:PULSE setting(S3) 5:Communication setting 6:FIV+FIC 7:MAX(FIV , FIC) 8:MIN(FIV , FIC)	0	☆
PA.03	PID action direction	0: Forward action 1: Reverse action	0	☆
PA.04	PID setting feedback range	0~65535	1000	☆
PA.05	Proportional gain Kp1	0.0~100.0	20.0	☆
PA.06	Integral time Ti1	0.01s~10.00s	2.00s	☆
PA.07	Differential time Td1	0.000s~10.000s	0.000s	☆
PA.08	Cut-off frequency of PID reverse rotation	0.00~maximum frequency	2.00Hz	☆
PA.09	PID deviation limit	0.0%~100.0%	0.0%	☆
PA.10	PID differential limit	0.00%~100.00%	0.10%	☆
PA.11	PID setting change time	0.00~650.00s	0.00s	☆
PA.12	PID feedback filter time	0.00~60.00s	0.00s	☆
PA.13	PID output filter time	0.00~60.00s	0.00s	☆
PA.14	Reserved	-	-	☆
PA.15	Proportional gain Kp2	0.0~100.0	20.0	☆
PA.16	Integral time Ti2	0.01s~10.00s	2.00s	☆
PA.17	Differential time Td2	0.000s~10.000s	0.000s	☆
PA.18	PID parameter switchover condition	0:No switchover 1:Switchover via S 2:Automatic switchover based on deviation	0	☆

Operation Instruction of NZ2000 Series Inverter

Function Code	Parameter Name	Setting Range	Default	Property
PA.19	PID parameter switchover deviation 1	0.0%~PA.20	20.0%	☆
PA.20	PID parameter switchover deviation 2	PA.19~100.0%	80.0%	☆
PA.21	PID initial value	0.0%~100.0%	0.0%	☆
PA.22	PID initial value holding time	0.00~650.00s	0.00s	☆
PA.23	Maximum deviation between two PID outputs in forward	0.00%~100.00%	1.00%	☆
PA.24	Maximum deviation between two PID outputs in reverse	0.00%~100.00%	1.00%	☆
PA.25	PID integral property	Unit's digit: Integral separated 0: Invalid 1: Valid Ten's digit: Whether to stop integral operation when the output reaches 0: Continue integral operation 1: Stop integral operation	00	☆
PA.26	Detection value of PID feedback loss	0.0%: Not judging feedback loss 0.1%~100.0%	0.0%	☆
PA.27	Detection time of PID feedback loss	0.0s~20.0s	0.0s	☆
PA.28	PID operation at stop	0: No PID operation at stop 1: PID operation at stop	0	☆
Group Pb: Swing Frequency, Fixed Length and Count				
Pb.00	Swing frequency setting mode	0: Relative to the central frequency 1: Relative to the maximum frequency	0	☆
Pb.01	Swing frequency amplitude	0.0%~100.0%	0.0%	☆
Pb.02	Jump frequency amplitude	0.0%~50.0%	0.0%	☆

Appendix A List of Function Parameters

Function Code	Parameter Name	Setting Range	Default	Property
Pb.03	Swing frequency cycle	0.1s~3000.0s	10.0s	☆
Pb.04	Triangular wave rising time coefficient	0.1%~100.0%	50.0%	☆
Pb.05	Set length	0m~65535m	1000m	☆
Pb.06	Actual length	0m~65535m	0m	☆
Pb.07	Number of pulses per meter	0.1~6553.5	100.0	☆
Pb.08	Set count value	1~65535	1000	☆
Pb.09	Designated count value	1~65535	1000	☆
Group PC: Multi-Reference and Simple PLC Function				
PC.00	Reference 0	-100.0%~100.0%	0.0%	☆
PC.01	Reference 1	-100.0%~100.0%	0.0%	☆
PC.02	Reference 2	-100.0%~100.0%	0.0%	☆
PC.03	Reference 3	-100.0%~100.0%	0.0%	☆
PC.04	Reference 4	-100.0%~100.0%	0.0%	☆
PC.05	Reference 5	-100.0%~100.0%	0.0%	☆
PC.06	Reference 6	-100.0%~100.0%	0.0%	☆
PC.07	Reference 7	-100.0%~100.0%	0.0%	☆
PC.08	Reference 8	-100.0%~100.0%	0.0%	☆
PC.09	Reference 9	-100.0%~100.0%	0.0%	☆
PC.10	Reference10	-100.0%~100.0%	0.0%	☆
PC.11	Reference11	-100.0%~100.0%	0.0%	☆
PC.12	Reference12	-100.0%~100.0%	0.0%	☆
PC.13	Reference13	-100.0%~100.0%	0.0%	☆
PC.14	Reference14	-100.0%~100.0%	0.0%	☆
PC.15	Reference15	-100.0%~100.0%	0.0%	☆
PC.16	Simple PLC running mode	0:Stop after the AC drive runs one cycle 1:Keep final values after the AC drive runs one cycle 2:Repeat after the AC drive runs one cycle	0	☆

Operation Instruction of NZ2000 Series Inverter

Function Code	Parameter Name	Setting Range	Default	Property
PC.17	Simple PLC retentive selection	Unit's digit:Retentive upon power failure 0:No 1:Yes Ten's digit:Retentive upon stop 0:No 1:Yes	00	☆
PC.18	Running time of simple PLC reference 0	0.0s(h)~6553.5s(h)	0.0s(h)	
PC.19	Acceleration/ deceleration time of simple PLC reference 0	0~3	0	
PC.20	Running time of simple PLC reference 1	0.0s(h)~6553.5s(h)	0.0s (h)	☆
PC.21	Acceleration/ deceleration time of simple PLC reference 1	0~3	0	☆
PC.22	Running time of simple PLC reference 2	0.0s(h)~6553.5s(h)	0.0s(h)	☆
PC.23	Acceleration/ deceleration time of simple PLC reference 2	0~3	0	☆
PC.24	Running time of simple PLC reference 3	0.0s(h)~6553.5s(h)	0.0s(h)	☆
PC.25	Acceleration/ deceleration time of simple PLC reference 3	0~3	0	☆
PC.26	Running time of simple PLC reference 4	0.0s(h)~6553.5s(h)	0.0s(h)	☆
PC.27	Acceleration/ deceleration time of simple PLC reference 4	0~3	0	☆

Appendix A List of Function Parameters

Function Code	Parameter Name	Setting Range	Default	Property
PC.28	Running time of simple PLC reference 5	0.0s(h)~6553.5s(h)	0.0s(h)	☆
PC.29	Acceleration/ deceleration time of simple PLC reference 5	0~3	0	☆
PC.30	Running time of simple PLC reference 6	0.0s(h)~6553.5s(h)	0.0s(h)	☆
PC.31	Acceleration/ deceleration time of simple PLC reference 6	0~3	0	☆
PC.32	Running time of simple PLC reference 7	0.0s(h)~6553.5s(h)	0.0s(h)	☆
PC.33	Acceleration/ deceleration time of simple PLC reference 7	0~3	0	☆
PC.34	Running time of simple PLC reference 8	0.0s(h)~6553.5s(h)	0.0s (h)	☆
PC.35	Acceleration/ deceleration time of simple PLC reference 8	0~3	0	☆
PC.36	Running time of simple PLC reference 9	0.0s(h)~6553.5s(h)	0.0s (h)	☆
PC.37	Acceleration/ deceleration time of simple PLC reference 9	0~3	0	☆
PC.38	Running time of simple PLC reference 10	0.0s(h)~6553.5s(h)	0.0s (h)	☆
PC.39	Acceleration/ deceleration time of simple PLC reference 10	0~3	0	☆

Operation Instruction of NZ2000 Series Inverter

Function Code	Parameter Name	Setting Range	Default	Property
PC.40	Running time of simple PLC reference 11	0.0s (h)~6500.0s (h)	0.0s (h)	☆
PC.41	Acceleration/ deceleration time of simple PLC reference 11	0~3	0	☆
PC.42	Running time of simple PLC reference 12	0.0s (h)~6500.0s (h)	0.0s (h)	☆
PC.43	Acceleration/ deceleration time of simple PLC reference 12	0~3	0	☆
PC.44	Running time of simple PLC reference 13	0.0s (h)~6500.0s (h)	0.0s (h)	☆
PC.45	Acceleration/ deceleration time of simple PLC reference 13	0~3	0	☆
PC.46	Running time of simple PLC reference 14	0.0s (h)~6500.0s (h)	0.0s (h)	☆
PC.47	Acceleration/ deceleration time of simple PLC reference 14	0~3	0	☆
PC.48	Running time of simple PLC reference 15	0.0s (h)~6500.0s (h)	0.0s (h)	☆
PC.49	Acceleration/ deceleration time of simple PLC reference 15	0~3	0	☆
PC.50	Time unit of simple PLC running	0: s (second) 1: h (hour)	0	☆

Appendix A List of Function Parameters

Function Code	Parameter Name	Setting Range	Default	Property
PC.51	Reference 0 source	0: Set by PC.00 1: FIV 2: FIC 3: reserved 4: PULSE setting 5: PID Set by preset frequency (P010), modified via terminal UP/DOWN	0	☆
Group PD: Communication Parameters				
PD.00	Baud rate	Unit's digit:MODBUS 0:300BPS 1:600BPS 2:1200BPS 3:2400BPS 4:4800BPS 5:9600BPS 6:19200BPS 7:38400BPS 8:57600BPS 9:115200BPS Ten's digit :Reserved Hundred's digit:Reserved Thousand's digit:Reserved	0005	☆
PD.01	Data format	0: No check, data format <8,N,2> 1: Even parity check, data format<8,E,1> 2: Odd Parity check, data format<8,O,1> 3: No check, data format <8,N,1> Valid for Modbus	3	☆
PD.02	Local address	1~247, 0: Broadcast address	1	☆
PD.03	Response delay	0ms~20ms	2	☆
PD.04	Communication timeout	0.0 (invalid) , 0.1s~60.0s	0.0	☆
PD.05	Modbus protocol selection	Unit's digit: Modbus protocol 0: Non-standard Modbus protocol 1: Standard Modbus protocol Ten's digit: reserved	1	☆
PD.06	Communication reading current resolution	0: 0.01A 1: 0.1A	0	☆

Operation Instruction of NZ2000 Series Inverter

Function Code	Parameter Name	Setting Range	Default	Property
Group PE: reserved				
Group PP: User-Defined Function Codes				
PP.00	User password	0~65535	0	☆
PP.01	Restore default settings	0: No operation 01: Restore factory settings except motor parameters 02: Clear records 04: Restore user backup parameters 501: Back up current user parameters	0	★
Group C0: Torque Control and Restricting Parameters				
C0.00	Speed/Torque control selection	0: Speed control 1: Torque control	0	★
C0.01	Torque setting source in torque control	0: Digital setting (C0.03) 1: FIV 2: FIC 3: reserved 4: PULSE setting 5: Communication setting 6: MIN (FIV,FIC) 7: MAX (FIV,FIC)	0	★
C0.03	Torque digital setting in	-200.0%~200.0%	150.0%	☆
C0.05	Forward maximum frequency in torque control	0.00Hz~maximum frequency	50.00Hz	☆
C0.06	Reverse maximum frequency in torque control	0.00Hz~maximum frequency	50.00Hz	☆
C0.07	Acceleration time in torque control	0.00s~650.00s	0.00s	★
C0.08	Deceleration time in torque control	0.00s~650.00s	0.00s	☆
Group C1~C4: reserved				
Group C5: Control Optimization Parameters				
C5.00	PWM switchover frequency upper limit	0.00Hz~15.00Hz	12.00Hz	☆

Appendix A List of Function Parameters

Function Code	Parameter Name	Setting Range	Default	Property
C5.01	PWM modulation mode	0: Asynchronous modulation 1: Synchronous modulation	0	☆
C5.02	Dead zone compensation mode selection	0: No compensation 1: Compensation mode 1 2: Compensation mode 2	1	☆
C5.03	Random PWM depth	0: Random PWM invalid 1~10: PWM carrier frequency random depth	0	☆
C5.04	Rapid current limit	0: Disabled 1: Enabled	1	☆
C5.05	Current detection compensation	0~100	5	☆
C5.06	Undervoltage threshold	60.0%~140.0%	100.0%	☆
C5.07	SFVC optimization mode selection	0: No optimization 1: Optimization mode 1 2: Optimization mode 2	1	☆
Group C6: FI Curve Setting(FI is FIV or FIC)				
C6.00	FI curve 4 minimum input	-10.00V~C6.02	0.00V	☆
C6.01	Corresponding setting of FI curve 4 minimum input	-100.0%~+100.0%	0.0%	☆
C6.02	FI curve 4 inflexion 1 input	C6.00~C6.04	3.00V	☆
C6.03	Corresponding setting of FI curve 4 inflexion 1 input	-100.0%~+100.0%	30.0%	☆
C6.04	FI curve 4 Inflexion 2 Input	C6.02~C6.06	6.00V	☆
C6.05	Corresponding setting of FI curve 4 inflexion 2 input	-100.0%~+100.0%	60.0%	☆
C6.06	FI curve 4 maximum input	C6.06~+10.00V	10.00V	☆
C6.07	Corresponding setting of FI curve 4 maximum input	-100.0%~+100.0%	100.0%	☆

Operation Instruction of NZ2000 Series Inverter

Function Code	Parameter Name	Setting Range	Default	Property
C6.08	FI curve 5 minimum input	-10.00V~C6.10	0.00V	☆
C6.09	Corresponding setting of FI curve 5 minimum input	-100.0%~+100.0%	-100.0%	☆
C6.10	FI curve 5 inflexion 1 input	C6.08~C6.12	3.00V	☆
C6.11	Corresponding setting of FI curve 5 inflexion 1 input	-100.0%~+100.0%	-30.0%	☆
C6.12	FI curve 5 inflexion 2 input	C6.10~C6.14	6.00V	☆
C6.13	Corresponding setting of FI curve 5 inflexion 2 input	-100.0%~+100.0%	30.0%	☆
C6.14	FI curve 5 maximum input	C6.12~+10.00V	10.00V	☆
C6.15	Corresponding setting of FI curve	-100.0%~+100.0%	100.0%	☆
C6.16	Jump point of FIV	-100.0%~100.0%	0.0%	☆
C6.17	Jump amplitude of FIV input	0.0%~100.0%	0.5%	☆
C6.18	Jump point of FIC input	-100.0%~100.0%	0.0%	☆
C6.19	Jump amplitude of FIC input	0.0%~100.0%	0.5%	☆
C9.00	PID Sleep frequency	0 ~ P0.12	00.00 Hz	☆
C9.01	PID Sleep Time	0 ~ 5000.0S	10.0 S	☆
C9.02	PID wake-up value	0 ~ 100.0 %	60.0 %	☆
Group CC: FI/FO Correction				
CC.00	FIV measured voltage 1	0.500V~4.000V	Factory-corrected	☆
CC.01	FIV displayed voltage 1	0.500V~4.000V	Factory-corrected	☆
CC.02	FIV measured voltage 2	6.000V~9.999V	Factory-corrected	☆

Appendix A List of Function Parameters

Function Code	Parameter Name	Setting Range	Default	Property
CC.03	FIV displayed voltage 2	6.000V~9.999V	Factory-corrected	☆
CC.04	FIC measured voltage 1	0.500V~4.000V	Factory-corrected	☆
CC.05	FIC displayed voltage 1	0.500V~4.000V	Factory-corrected	☆
CC.06	FIC measured voltage 2	6.000V~9.999V	Factory-corrected	☆
CC.07	FIC displayed voltage 2	6.000V~9.999V	Factory-corrected	☆
CC.08	Reserved		Factory-corrected	☆
CC.09	Reserved		Factory-corrected	☆
CC.10	Reserved		Factory-corrected	☆
CC.11	Reserved		Factory-corrected	☆
CC.12	FOV target voltage 1	0.500V~4.000V	Factory-corrected	☆
CC.13	FOV measured voltage 1	0.500V~4.000V	Factory-corrected	☆
CC.14	FOV target voltage 2	6.000V~9.999V	Factory-corrected	☆
CC.15	FOV measured voltage 2	6.000V~9.999V	Factory-corrected	☆
CC.16	Reserved		Factory-corrected	☆
CC.17	Reserved		Factory-corrected	☆
CC.18	Reserved		Factory-corrected	☆
CC.19	Reserved		Factory-corrected	☆

Group D0: Monitoring Parameters

Function Code	Parameter Name	Unit
D0.00	Running frequency(Hz)	0.01Hz
D0.01	Set frequency(Hz)	0.01Hz
D0.02	Bus voltage(V)	0.1V

Operation Instruction of NZ2000 Series Inverter

Function Code	Parameter Name	Unit
D0.03	Bus voltage(V)	1V
D0.04	Output current(A)	0.01A
D0.05	Output power(kW)	0.1kW
D0.06	Output torque(%)	0.1%
D0.07	S input state	1
D0.08	M01 output state	1
D0.09	FIV voltage(V)	0.01V
D0.10	FIC voltage(V)	0.01V
D0.11	Reserved	
D0.12	Count value	1
D0.13	Length	1
D0.14	Load speed	1
D0.15	PID setting	1
D0.16	PID feedback	1
D0.17	PLCstage	1
D0.18	Input pulse frequency	0.01kHz
D0.19	Reserved	
D0.20	Remaining running time	0.1Min
D0.21	FIV voltage before correction	0.001V
D0.22	FIC voltage before correction	0.001V
D0.23	Reserved	
D0.24	Linear speed	1m/Min
D0.25	On the current time	1Min
D0.26	The current running time	0.1Min
D0.27	Pulse input frequency	1Hz
D0.28	Communication setting value	0.01%
D0.29	Reserved	
D0.30	Reserved	
D0.31	Auxiliary frequency Y	0.01Hz
D0.32	View any memory address values	1

Appendix A List of Function Parameters

Function Code	Parameter Name	Unit
D0.33	Reserved	
D0.34	Motor temperature	1°C
D0.35	Target torque	0.1%
D0.36	Reserved	
D0.37	Power factor angle	0.1
D0.38	Reserved	
D0.39	Target voltage upon V/F separation	1V
D0.40	Output voltage upon V/F separation	1V
D0.41	Reserved	
D0.42	Reserved	
D0.43	Reserved	
D0.44	Reserved	
D0.45	Current fault code	0

Appendix B

Communication Protocol

NZ2000 series inverter provides RS232 / RS485 communication interface, and support the Modbus communication protocol. Users can be achieved by computing machine or PLC central control, through the communication protocol set inverter running commands, modify or read function code parameters, read the inverter working condition and fault information, etc.

1, The agreement content

The serial communication protocol defines the serial communication transmission of information content and format. Including: host polling or wide planting format; Host encoding method, the content includes: the function of the required action code, data transmission and error checking, etc. From the ring of machine should be used is the same structure, content including: action confirmation, return the data and error checking, etc. If there was an error in receiving information from a machine, or cannot achieve the requirements of the host, it will organize a fault feedback information in response to the host.

2, Application methods

Application mode inverter with RS232 / RS485 bus access to the "from" single main PC/PLC control network.

3, Bus structure

(1) The interface way RS232 / RS485 interface hardware
(2) Asynchronous serial transmission mode, half-duplex transmission mode. At the same time the host and the only one to send data from the machine and the other can only receive data. Data in the process of serial asynchronous communication, the form

of a message, a frame of a frame to send

(3) Topological structure from single host machine system. From the machine address set in the range of 1 ~ 247, 0 for broadcast communication address. In the network from the machine address must be unique.

4, Protocol Description

NZ2000 series inverter is a kind of asynchronous serial port communication protocol of master-slave Modbus communication protocol, the network has only one equipment (host) to establish agreement (called "query/command"). Other equipment (machine) can only by providing data response of the main machine "query/command", or "query/command" according to the host to make the corresponding action. Host in this refers to the personal computer (PC), industrial control equipment or programmable logic controller (PLC), etc., from machine refers to NZ2000 inverter. The host can communicate to a separate from the machine, also can to all under a broadcast information from machine release. For access to the host alone "query/command", from the machine to return to a information (called response), for radio host information, from the machine without feedback response to the host.

5, Communications data structure

Communication data structure NZ2000 series inverter of the Modbus protocol communication data format is as follows: using the RTU mode, messages are sent at least begin with 3.5 characters pause time interval.

In network wave rate under varied characters of the time, this is the most easy to implement (below T1, T2, T3, T4). Transmission equipment is the first domain address.

The transmission character of you can use is the hex 0...9, A...F. Continuously detect network bus network facilities, including pause interval of time. When the first domain (domain) to receive, every equipment decoding to determine whether to own. After the last transmission character, a pause at least 3.5 characters time calibration for the end of the message. A new message can be started after the pause.

The entire message frame must be as a continuous flow of transmission. If the time frame to complete more than 1.5 characters before pause time, receiving equipment will refresh incomplete

Operation Instruction of NZ2000 Series Inverter

message and assume that the next byte is a new message the address of the domain. Likewise, if a new message in less than 3.5 characters of time and then a message before, receiving equipment will think it is a continuation of the previous message. This will result in an error, because in the final CRC field value can't be right.

RTU frame format:

The frame header START	3.5 characters
Slave address ADR	Communication address: 1~247
command code CMD	03: Read the machine parameters; 06: write the machine parameters
Data content DATA (N-1)	Information content: Function code parameter address, function code number of parameters, function code parameter values, etc
Data content DATA (N-2)	
.....	
Data content DATA0	
high-order position of CRC CHK	estimated value: CRC value
low-order position of CRC CHK	
END	3.5 characters'time

CMD(Command instruction)and DATA(the description of data word) command code:03H,read N word(Word)(Can read the most words of 12)For example,From the machine address of 01 inverter startup F105 continuous read for two consecutive values

The host command information

ADR	01H
CMD	03H
high-order position of the starting address	F1H
low-order position of the starting address	05H
high-order position of register	00H
low-order position of register	02H
low-order position of CRC CHK	Wait to calculate the CRC CHK values
high-order position of CRC CHK	

In response to information from the slave machine

Set PD.05 to 0:

ADR	01H
CMD	03H
high-order position of bytes	00H
low-order position of bytes	04H
Data high-order position of F002H	00H
Data low-order position of F002H	00H

Appendix B Communication Protocol

Data high-order position of F003H	00H
Data low-order position of F003H	01H
low-order position of CRC CHK	Wait to calculate the CRC CHK values
high-order position of CRC CHK	

Set PD.05 to 1:

ADR	01H
CMD	03H
The number of bytes	04H
Data high-order position of F002H	00H
Data low-order position of F002H	00H
Data high-order position of F003H	00H
Data low-order position of F003H	01H
low-order position of CRC CHK	Wait to calculate the CRC CHK values
high-order position of CRC CHK	

The command code:06H write a word(Word)For example,write 000(BB8H)to slave machine.

Address 05H inverter's F00AH address.

The host command information

ADR	05H
CMD	06H
high-order position of data address	F0H
low-order position of data address	0AH
high-order position of information content	0BH
low-order position of information content	B8H
low-order position of CRC CHK	Wait to calculate the CRC CHK values
high-order position of CRC CHK	

In response to information from the slave machine

ADR	02H
CMD	06H
high-order position of data address	F0H
low-order position of data address	0AH
high-order position of information content	13H
low-order position of information content	88H
low-order position of CRC CHK	Wait to calculate the CRC CHK values
high-order position of CRC CHK	

Check way—CRC Check way: CRC(Cyclical Redundancy Check) use RTU frame format, The message includes error detection field based on the method of CRC. CRC domain test the whole content of a message. CRC domain is two bytes, contains a 16-bit binary values. it is calculated by the transmission equipment, added to the

message.receive messages the device recalculate.And compared with receives the CRC in the domain of value, if the two CRC value is not equal, then there is an error in transmission.

CRC is saved in 0xFFFF,Then call a process to continuous 8-bit bytes of the message and the values in the current register for processing.Only 8 bit data in each character of CRC is effective,Starting bit and stopping bit and parity bits are invalid.

In the process of CRC,Each of the eight characters are separate and dissimilar or register contents(XOR),The results move to the least significant bit direction, set the most significant bit to 0. LSB is extracted to test,if set LSB to 1,Register and preset value dissimilarity or alone,if set LSB to 0, is not to.The whole process will repeat 8 times.when the last time (the eighth time) is completed,next 8-bit bytes and separate and register under the current value of the alien or.The values in the final register,Is all bytes in the message is executed after the CRC value.

When CRC added to the messages .The low byte to join first and then high byte.CRC Simple function is as follows:

```
unsigned int crc_cal_value(unsigned char *data_value,unsigned char data_length)
{
int i;
unsigned int crc_value=0xffff;
while(data_length-)
{
crc_value^=*data_value++;
for(i=0;i<8;i++)
{
If(crc_value&0x0001)
crc_value=(crc_value>>1)^0xa001;
else
crc_value=crc_value>>1;
}
}
Return(crc_value);
}
```

Address definition of communication parameters

This part is the content of the communication, used to control the operation of the inverter, inverter status and related parameters setting.Read and write functional code parameter (some function

Appendix B Communication Protocol

code which can not be changed, only for the use of manufacturers or monitoring) : function code parameter address label rules:

By function block number and the label for the parameter address representation rules .High byte: F0~FF(P group),A0~AF(C group),70~7F(D group)low byte:00~FF

Such as:P3.12,The address is expressed as F30C; attention: PF group:Neither read the parameters, and do not change parameters;Group D group: only can read, do not change the parameters.

When some parameters in inverter is in operation, do not change;Some parameters of the inverter in any state, cannot be changed;Change function code parameters, but also pay attention to the range of parameters, units, and related instructions.

In addition, because the EEPROM is stored frequently, the service life of the block can reduce the the life of the block EPROM, so some function code under the mode of communication, do not need to be stored, just change the value of RAM.If it is P group of parameters, in order to realize the function, as long as putting this function code address high F into 0 can be achieved.If it is C group of parameters, in order to realize the function, as long as putting the function code the address of high A into 4 can be achieved. Corresponding function codes are shown as the following address: the high byte: 00 ~ 0F (P group), 40 ~ 4F(group B) low byte: 00 to FF

Such as:

Function code P3.12 is not stored in the EEPROM,The address is expressed as 030C;Function code C0-05 is not stored in the EEPROM,The address is expressed as 4005; The address representation can only do writing RAM,can't do reading action,when reading,it is invalid address. For all the parameters, can also use the command code 7H to implement this function.

Stopping/starting parameters:

Parameter address	Parameter description
1000	Communication Setting value (-10000~10000) (decimal system)
1001	Operating frequency
1002	Bus voltage
1003	output voltage
1004	current output
1005	output power
1006	output torque

Operation Instruction of NZ2000 Series Inverter

1007	running velocity
1008	S Input Flag
1009	M01 output Flag
100A	FIV voltage
100B	FIC voltage
100C	Reserved
100D	count value input
100E	The length of the input
100F	The load speed
1010	PID setting
1011	PID feedback
1012	PLC steps
1013	PULSE the input pulse frequency,unit 0.01kHz
1014	Reserved
1015	The remaining running time
1016	FIV before correction voltage
1017	FIC before correction voltage
1018	Reserved
1019	Linear velocity
101A	the current access to electricity time
101B	the current running time
101C	PULSE input pulse frequency,unit 1Hz
101D	Communication Setting value
101E	Reserved
101F	The main frequency X show
1020	Auxiliary frequency Y show

attention:

Communication setting value is relative percentage, 10000 corresponds to 100.00% and - 10000-100.00%.The frequency of dimensional data, the percentage is relative to the percentage of maximum frequency (P0.12);Counter rotating torque dimensional data, the percentage is P2.10.

Control command input to the inverter:(write-only)

The command word address	Command function
2000	0001:Running forward
	0002:Reverse running
	0003:normal inching turning
	0004:Reversal point move
	0005:Free downtime
	0006:Slowing down
	0007:Failure reset

Appendix B Communication Protocol

Read the inverter state: (read-only)

Status word address	Status word function
3000	0001:Running forward
	0002:Reverse running
	0003:closing down

Parameters lock password check: (if return for 8888H,it indicates that the password check through)

Password address	The content of the input password
1F00	*****

Command address	Command content
2001	BIT0:(reserved) BIT1:(reserved) BIT2:RA-RB-RC output control BIT3:reserved BIT4:M01 output control

Analog output FOV control: (write-only)

Command address	Command content
2002	0~7FFF represent 0%~100%

Analog output control:(Reserved)

Command address	Command content
2003	0~7FFFrepresent 0%~100%

PULSE (PULSE) output control: (write -only)

Command address	Command content
2004	0~7FFFrepresent 0%~100%

Inverter fault description:

Inverter fault address	Inverter fault information
8000	0000:failure-free 0001:reserve 0002:Accelerate over current 0003:Slow down over current 0004:Constant speed over current 0005:Accelerate over the voltage 0006:Slow down over voltage 0007:Constant speed over voltage 0008:Buffer resistance overload fault 0009:Under-voltage fault 000A:The inverter overload 000B:Motor overload 000C:reserved 000D:The output phase 000E:Module is overheating 000F:External fault 0010:Abnormal communication

Operation Instruction of NZ2000 Series Inverter

8000	0011:Abnormal contactor 0012:Current detection fault 0013:Motor tuning fault 0014:reserved 0015:Abnormal parameters, reading and writing 0016:Inverter hardware failure 0017:Motor for short circuit fault 0018:reserved 0019:reserved 001A:Running time reached 001B: reserved 001C: reserved 001D: Accumulative power-on time reached 001E:Load becoming 0 001F:PID feedback lost during running 0028:With-wave current limit fault 0029:Motor switchover fault during running 002A: Too large speed deviation 002B: Motor over-speed 002D:Motor overheat 005A:Encoder line number setting error 005B:Don't connect the encoder 005C:Initial position fault 005E:Speed feedback error
Communication failures address	Fault feature description
8001	0000:failure-free 0001:Password mistake 0002:The command code error 0003:CRC Checking error 0004:Invalid address 0005:Invalid parameter 0006:correcting parameter is invalid 0007:System is locked 0008:Block is EEPROM operation

PD group Communication parameters show

	Baud rate	The factory value	0005
PD.00	setting range		units' digit:MODUBS Baud rate 0:300BPS 1:600BPS 2:1200BPS 3:2400BPS 4:4800BPS 5:9600BPS 6:19200BPS 7:38400BPS 8:57600BPS 9:115200BPS

This parameter is used to set data transfer rate between the PC

Appendix B Communication Protocol

and inverter. Notice that setting the baud rate of upper machine and inverter must agree, otherwise, the communication can't carry on. The faster the baud rate, the greater the communication.

PD.01	The data format	The factory value	3
	setting range	0: No check: The data format <8,N,2> 1: Even-parity: The data format <8,E,1> 2: Odd parity check: The data format <8,O,1> 3: No check: The data format <8-N-1>	

PC and data format set by the inverter must agree, otherwise, the communication can't carry on.

PD.02	The machine address	The factory value	1
	setting range	1~247, 0 is the broadcast address	

When the machine address set to 0, namely for the broadcast address, realize PC broadcasting functions.

The machine address has uniqueness (except the broadcast address), which is to achieve the basis of upper machine and inverter peer-to-peer communications.

PD.03	Response latency	The factory value	2ms
	setting range	0~20ms	

Response latency: refers to the inverter data to accept the end up to a upper machine to send data in the middle of the interval of time. If the response time delay is less than the system processing time, the response time delay will be subject to system processing time, processing time, such as response time delay is longer than system after processing the data, the system will delay waiting, until the response delay time to up to a upper machine to send data.

PD.04	Communication timeout	The factory value	0
	setting range	0.0 s (invalid) 0.1~60.0s	

When the function code is set to 0.0 s, communication timeout parameter is invalid.

When the function code set to valid values, if a communication and the interval time of the next communication beyond the communication timeout, system will be submitted to the communication failure error (CE). Usually, it is set into is invalid. If, in the continuous communication system parameter set the time, you can monitor the communication status.

Operation Instruction of NZ2000 Series Inverter

PD.05	Communication protocol selection	The factory value	1
	setting range	0: Non standard Modbus protocol 1: The standard Modbus protocol	

PD.05=1:choose the standard Modbus protocol

PD.05=0: when reading command ,Returns number of bytes from the machine is a byte more than the standard Modbus protocol, detailed in this agreement

5 Communication data structures.

PD.06	Read the current resolution	The factory value	1
	setting range	0: 0.01A 1: 0.1A	

Used to determine the communication while reading the output current, current value of the output units.

NIETZ ELECTRIC CO.,LTD
TEL:+86 21 33634649
www.nietz.cn
E-mail: info@nietz.cn



Room 1506, XuHui Building ,No.188 YuDe Road Shanghai, China 200030